

# AUTOMATION OF BEAM STRAIGHTNESS MEASUREMENT WITH IMAGE PROCESSING TOOLS

António Fernando Ribeiro

Departamento de Electrónica Industrial, Universidade do Minho, Guimarães, Portugal  
Tel: +351 (0)53 510190, Fax: +351 (0)53 510189, email: fernando@zeus.dei.uminho.pt

## **Abstract:**

For measuring the straightness of moving steel beams, a methodology was developed and an inspection machine was built with a set of image processing tools to control it.

The method consists in developing a specific software to perform three main tasks: reading the position of the beams in several positions; correlating all those positions monitored by the cameras; and reporting the quality of the beam straightness. Computer vision technology as a non contact measuring device is used by the inspection machine. From the production process the beams roll on a conveyor therefore several video cameras are used to log information not only about the lateral position but also the height of the steel beams.

The user can decide the number of cameras and the distance between them. Should one camera fail or be switched off, the measuring system is not affected as long as the system has a minimum of three cameras extracting acceptable points.

The system output is the non linearity deviation of the beam, compensating factors for lateral or angular movements in the horizontal measuring plane of the beam and the beam profile. The output is displayed in a computer screen, according to the line method and the least square method.

**Keywords:** Image Processing, Lasers, Beam Straightness Measurement, Steel Beams .

## **1. INTRODUCTION**

Manufacturing companies need to improve inspection methods of their products because of the ever increasing demands of quality control. Automated inspection is one of the most favoured systems because there are no errors introduced by people, all the products are inspected and throughput is not reduced due to the time necessary to inspect. In other words the efficiency of inspection is improved and the labour required is much reduced.

The problem to be addressed in this paper is that of monitoring the straightness of steel beams which are produced at a rate of 2 metres per second. The present method of assessing distortion of newly manufactured steel beams is entirely manual and is therefore very labour intensive. A string is attached to one end of the steel beam and stretched to the other end and this allows the deviation in straightness to be visually observed. Just 10% of the steel beams are fully inspected and there is consequently a high probability of defective products leaving the factory. Another problem was that for long beams up to the maximum manufactured length of 32 metres it becomes very

difficult to maintain the straightness of the string because it tended to sag due to its own weight.

## **2. THE PROTOTYPE MACHINE**

A prototype machine using image processing for analysing the steel beams was previously built by Anacleto (Ref. [1]) and it consists of three Reading Heads each of which comprises a video camera (all equally spaced) with the respective frame grabber and a laser beam which is focused onto the Steel Beam (Ref. [2]). The laser beam takes the form of a fan shaped slit of light which impinges onto the Steel Beam, as shown in figure 1. Each pair of Reading Heads is coupled to a slave computer used to analyse the video data, to establish the edges of the beams and to calculate common reference co-ordinates for setting beam position in each picture. The beam profile is then calculated and analysed against appropriate British Standards from which a single reject or accept decision is made.

Although the prototype machine had been previously tested in relation to the task requirement, it was evident that several aspects could be considered for improving the precision of the system.

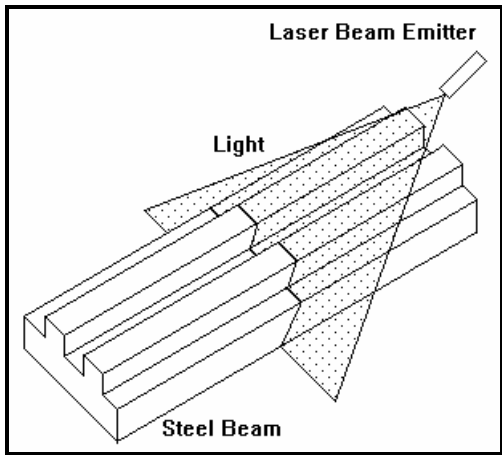

Figure 1 - Laser Beam Emitter

After investigating the measurement accuracy of the prototype machine some disadvantages were identified: for example, operating with just three cameras, means that their distances relative to each other have to be exactly the same and also there is no measurement of the height of the steel beam. An image processing facility named Calliper Tool was created to give the position of the steel beams together with specific mathematics to co-relate these co-ordinates given from the VDU screen. The principal innovation is that the method proposed in this paper can cope with more than three reading heads, can accommodate different distances between these reading heads and can measure the height of the beam. This will provide more reliable results.

It is important to point out that the main reason for changing from three to six reading heads is that the more co-ordinates measured in each picture, the more accurate the resultant profile will be, as proved in (Ref. [3]) and shown in figure 2.

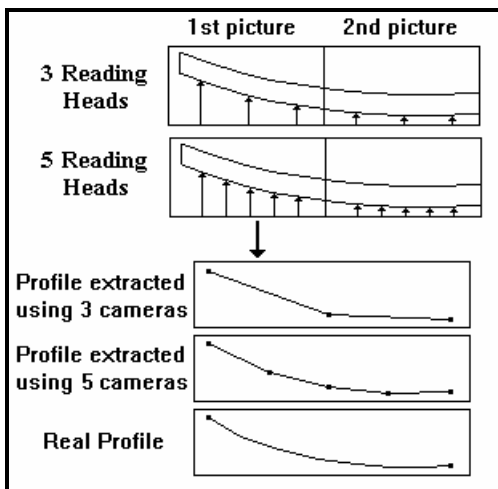

Figure 2 - Process to teach the system to extract points

### 3. BEAM PROFILE EXTRACTION

A Digital Image Processing System consists at least of one camera, one VDU to show what the camera is observing connected to a computer in order to carry out the image processing. The computer will analyse the picture and calculate various features of the image depending not only on the software program but also on the purpose of the system.

In an ordinary system the VDU is black and white and it has a resolution of typically 768 by 288 pixels or picture elements (tiny dots that make up a computer graphics picture). The smaller the size of each pixel, the greater their number and thus the higher the resolution of the picture as noted by Zuech and Miller (Ref. [4]).

The computer used a relatively fast machine due to the large amount of mathematical calculations necessary to interpret the image, analyse it and process it. The amount of computer memory is also important because images require a large amount of memory to be treated.

The straightness measuring machine already working in the company is a large steel structure with several devices to control the position of a serial of large hammers which straighten the emerged beam. The position of these hammers obscures the view of the steel beam from some of the reading heads and it is not possible to predict which reading heads are obscured because of the hammers have several degrees of freedom. It has been estimated that the view of at least two reading heads will sometimes be obscure and therefore it was decided to base an improved system on the use of six reading heads aimed at some strategic points on the beam. Not all the reading heads can see the laser beam projected on the steel beam at the same instant but the minimum of reading heads operational at any time will be four. The mathematical procedure has therefore to cope with a different number of reading heads and also with different distances between them.

The proposed image processing system will consist of six Reading Heads each consisting of a Video Camera, a Frame Grabber and a Laser Beam, 4 computers (1 main and 3 slaves) and a VDU screen. All computers are 80486 Intel based PC's. Each one of the three slaves reads images from two cameras. The main computer is responsible for reading the global parameters of the system, calibrating the machine, performing the mathematical procedures and for all communications including that to the operator.

High accuracy is fundamental when extracting the points of the beam from the video information. A sub-pixel technique to increase the accuracy of the results has been used.

British Steel manufactures around about 500 different cross sections although in this paper it is just considered one example. The steel beam passes through the inspection system on a conveyor at a velocity of 2 metres per second which increases the difficulty of extracting the points to be measured. When the laser beam reaches the steel beam, as shown in Figure 1 the resultant image seen by the cameras will be shown as in Figure 3. The formation of these lines is entirely due to the inclination of the laser beam emitters. The machine operator decides the most appropriate point or pair of points to use for a particular steel beam cross section and then teaches the system to find this characteristic. These points are recorded in the computer.

Figure 3 shows an example of extracting one particular point. The operator selects the area where the image can appear on the VDU screen by the use of a masking window. The main window shows the projection of the laser beam on the steel beam having a square cross section. Four charts appear after the user has selected the appropriate window. The first chart at the bottom of the window and the first chart on the left hand side represent the summation of the intensity of the black pixels in the X and Y directions. The peaks in these two charts represent the position at which the lines of the laser beam are situated. The second chart at the bottom and on the left hand side are a graphical representation of the derivatives of the first pair of charts.

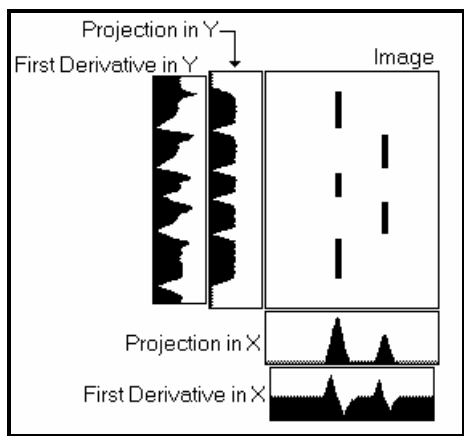

Figure 3 - Process to teach the system to extract points

Each peak or trough in these derivative charts represent the edges of the lines. Using this technique it is therefore possible to find the edges and the positions of the lines projected by the laser beam. It is important to note that this figure represents an ideal case because real images frequently contain "noise" and the edges are less than perfect.

The reason for using the derivative chart is that the peak blackness value does not represent the centre of

the Laser Beam line. It was decided to apply a statistical technique to the data in order to establish a more precise value and to achieve sub-pixel accuracy.

Figure 4 shows an example of two charts in the X direction. The first chart represents the projection of the image and the second one its derivative. In this figure, *a* represents a peak blackness value but not the centre of the Laser Beam line. The derivative is therefore used to locate where the projection chart starts increasing and decreasing its black value. The two lines represented by the peak and trough of the derivative chart represent the limits of the area about which the average value can be determined.

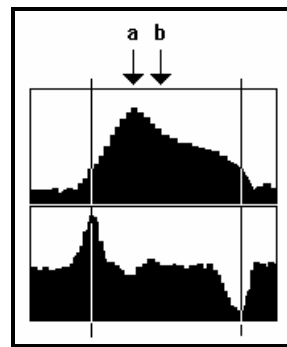

Figure 4 - Example of a peak in X direction

After the statistical calculation procedure the true result is represented by average value *b*. This value can be determined to a precision value between two discrete pixel values. The resolution would be limited to the number of pixels if just the peaks values had been used.

The shape of the image on the Steel Beam caused by the Laser Beam always takes the form of a straight vertical line as observed by the Video Camera. Horizontal lines can never be formed by the Laser Beam so the statistical technique is only ever in the X direction. It is only necessary to find the edges of the lines in the Y direction and not their centre.

#### 4. CALLIPER TOOL

Calliper Tool is an image processing software tool developed for locating the edges of images using the derivative characteristics described previously. The operator has to define what he is looking for to teach the system and then the system will give back an array of possible solutions as well as a score for each solution. The definition of what the user wants to find, is saved in a Configuration File with certain rules as shown in the following example:

**PAIR=HORIZONTAL**

**POLARITY=+-**  
**EDGE STRENGTH=50**  
**DISTANCE=10 80%**  
**ABSOLUTE POSITION=100 20%**

The first word indicates the number of points. The possible words to be used here are SINGLE or PAIR which simply means one or two points. The second word on the first line describes the axis of the search and this can be HORIZONTAL or VERTICAL. This statement has to be in the first line but the order of the other lines is not important.

In the second line the word POLARITY means the order of the points. In this example it means an increase of black density followed by a decrease in black density. The sign '+' means increasing and the sign '-' means decreasing. There are 4 possible combinations with these symbols for a PAIR of points which are '++', '+-', '-+' and '--'. For a SINGLE point there are just two possibilities, '+' or '-'. This line is compulsory.

In the third line the words EDGE STRENGTH represent the minimum height necessary to consider a value to be a peak. This means that for a value to be a peak it must exceed neighbouring peaks by an amount greater than the average plus the EDGE STRENGTH. This is also a compulsory line.

The word DISTANCE is only applied when looking for a PAIR of points. This statement represents the expected distance between a pair of points. The second number is a percentage which represents the importance attached to finding a particular feature of the image. In this case 80% implies that the user is more interested in the correct distance between the two points rather than their ABSOLUTE POSITION (20%). The user can ignore this line if not interested in the distance between the pair of points because this line is not compulsory.

The last line of this Configuration File is the ABSOLUTE POSITION and this is used when the position of the point or the first point when there are a pair of points, is expected to be in a certain position. In this case the point is expected to be in position 100 but the importance has been set at just 20% which means that it is not very important. The sum of these two importance percentage factors (DISTANCE and ABSOLUTE POSITION) must be 100%. This line is not compulsory.

When the system starts running it reads the Configuration File, analyses the image and gives a score to each one of all the possible solutions. The system then selects the best score and this will be the final result. The portion of image that the system has to analyse is also defined in the program but this is not a parameter in the Calliper Tool software.

## 5. IMAGE PROCESSING TESTS

The image processing system was tested to analyse its repeatability and timing. Thus, an object having the shape of a Steel Beam was placed in the field of view of a Reading Head and this was tested by taking 1000 pictures of the same data and extracting the two edges of that object. The principal reason for doing 1000 tests was to achieve an accurate measurement of the processing time required and to check the system repeatability. After teaching the system to look for the two edges, the software developed was run and all the resultant values were stored. The values stored were the co-ordinates of the first point, of the second point and the distance between them.

	peak pixels	trough pixels	Dist. pixels	processing time
Max	29.496	35.482	5.994	110.000
Average	29.490	35.478	5.987	61.802
Min	29.486	35.473	5.978	50.000
Max-Aver.	0.006	0.004	0.007	
Aver.-Min	0.004	0.005	0.009	

Table 1 - Peak, trough and distance found in one edge

Table 1 shows the values for a window size of 64 by 64 pixels. The final column shows the processing time required to read the points. The three columns in the centre represent the first point, the second point and the distance between them in terms of pixels. The **Max** value represents the maximum value of the 1000 readings, the **Average** value represents the numerical average of the 1000 readings, and the **Min** value represents the minimum value of the 1000 readings.

All these tests were also carried out for image windows in which 6 elements could be found and this clearly requires more calculation time. The following table provides a comparison between the average time for 1 element and for 6 elements in the single VDU image.

Window Size	64x64	128x128	256x256
1 element	64	172	580
6 elements	118	230	636
difference	54	58	56

Table 2 - Processing time for different numbers of elements and window sizes

The major conclusion to be drawn is that the number of elements found in one image does not significantly influence the time required to analyse each element. The processing time required is however significantly affected by the window size.

It is important to mention that the machine used for these tests was an INTEL 80386 with 33Mhz based microprocessor without a mathematical co-processor. The computer used in the real machine is an INTEL 80486 with 33Mhz based microprocessor. The speed of this computer will be 4 times faster therefore all these times have to be divided by 4 which significantly increases the speed of the system.

## 6. BEAM SHAPE DETERMINATION

An important issue in this Section is to explain how the new mathematical technique operates. For this purpose it is necessary to understand the purpose of each Reading Head and how the Y co-ordinate points are extracted and used. The following figure will be used to illustrate this task.

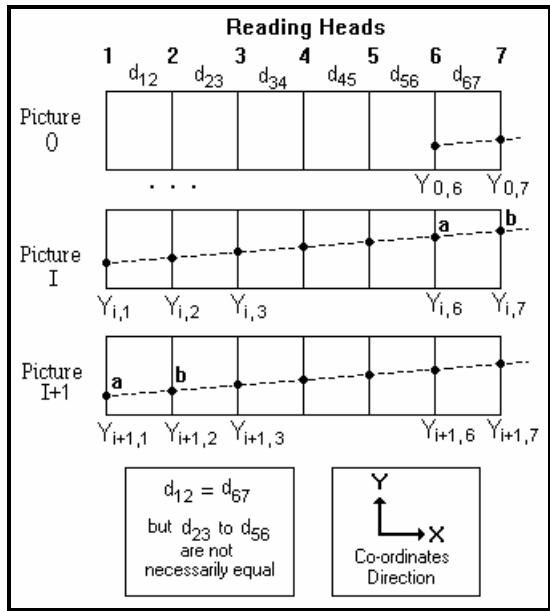

Figure 5 - Extraction of points using 7 Reading Heads

Where  $d_{ij}$  is the distance between cameras  $i$  and  $j$ .  
 $Y_{ij}$  is the Y co-ordinate in picture  $i$  in camera  $j$ .

Figure 5 represents a system with 7 Reading Heads and 3 sets of pictures though 2 of them are consecutive pictures. Picture 1 is at instant  $\mathbf{0}$ , Picture 2 is at instant  $\mathbf{I}$  and Picture 3 represents the instant  $\mathbf{I+1}$ . Considering dynamic measurement, three movements have to be considered. The *Progressive Movement* of the beam in the X direction, the *Linear Movement* of the beam in the Y direction and its *Angular Movement* about the Y direction.

The *Progressive Movement* is the normal forward movement when the beam is on the conveyor and this provides the X position of the beam. It is assumed that the conveyor has constant speed, but this could

be measured more accurately by the use of a position encoder attached to one of the conveyor rollers.

The *Linear Movement* is the movement of the beam as it moves from side to side on the conveyor and this is a movement in the Y direction. This movement is measured by comparing the same point of the beam in two consecutive pictures. There is no *Linear Movement* if the Y co-ordinate is at the same point of the Steel Beam in two consecutive pictures.

The *Angular Movement* is the movement of the beam when one end moves more than the other, in other words it is when the movement causes the beam to make an angle with respect to the previous picture. This movement is calculated by comparing two points of the Steel Beam in two consecutive pictures. There is no *Angular Movement* if there is no difference between two Y co-ordinates in two consecutive pictures.

The last two Reading Heads are used to calculate the linear and angular movements between each picture and the previous one in order to calculate all the final Y positions read by the other Reading Heads. These points read on the Steel Beam have to be the same in two consecutive pictures and this is the reason why the distance between Reading Heads 1 and 2 must be equal to the distance between Reading Heads  $N-1$  and  $N$ . It is important to note that this is the reason why just  $N-2$  points are mathematically generated per picture where  $N$  is the number of Reading Heads.

The *Linear Movement* formula (1) does not depend on the distance between the cameras and the formula represents the difference between the Y co-ordinates between two consecutive pictures and the same point of the Steel Beam is measured in these two pictures. The linear movement value is equal for all the Reading Heads in one set of pictures. In Figure 5 point **a** is used to measure the linear movement. So, the general formula is:

$$LM_i = Y_{i,1} - Y_{i-1,N-1} \quad (1)$$

To measure the angular movement it is necessary to consider two points at two different instants. There is Angular Movement if the difference between the points at one instant changes from the difference between the two points at the next instant. In the example shown in figure 5, points **a** and **b** are used to measure the angular movement between two consecutive pictures. The angular movement for the original system gave the following formula:

$$AM_{i+1} = (Y_{i,6} - Y_{i,7}) - (Y_{i+1,1} - Y_{i+1,2}) \quad (2)$$

In this new work, there is a new concept which is that of Angular Displacement. It is now important to distinguish between Angular Movement and Angular Displacement. The *Angular Movement* is the angle that the beam makes with respect to the previous picture and the *Angular Displacement* is the displacement in the Y axis caused by that angle per unit metre of Steel Beam, so the above equation must be divided by the distance between the Reading Heads. The formula for the *Angular Displacement* can therefore be represented by:

$$AD_i / \text{unit metre} = 1 * \left( \frac{Y_{i-1,N-1} - Y_{i-1,N}}{d_{N-1,N}} - \frac{Y_{i,1} - Y_{i,2}}{d_{1,2}} \right) \quad (3)$$

The *Net Angular Displacement* formula consists of the summation of all the previous angular displacements before the current 'set of pictures'. It represents the Y co-ordinate of a straight beam that didn't move angularly. To find this value, the Angular Displacements since the first 'set of pictures' have to be added. This Net Angular Displacement value is used for all the Reading Heads in one set of pictures.

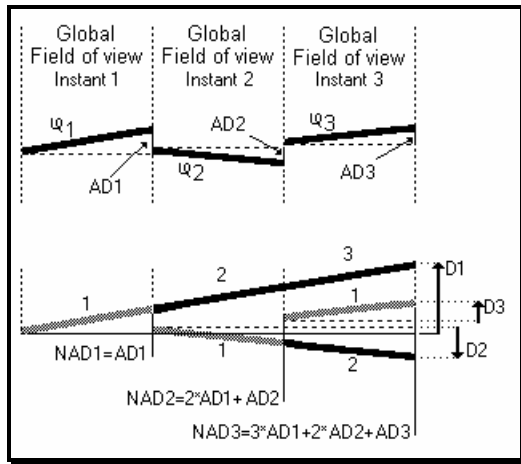

Figure 6 - Net Angular Movement

Angular Displacement (AD), top part of Figure 6, is next used to calculate the Net Angular Displacement (NAD), bottom part of Figure 6. Considering instant 1, NAD is now equal to the AD of instant 1. Considering instant 2, NAD is now  $2 * AD_1 + AD_2$ . Considering instant 3, NAD is now equal to  $3 * AD_1 + 2 * AD_2 + AD_3$ .

$$NAD_1 = 1 * AD_1$$

$$NAD_2 = 2 * AD_1 + 1 * AD_2$$

$$NAD_3 = 3 * AD_1 + 2 * AD_2 + 1 * AD_3$$

The general formula for Net Angular Displacement at instant  $i$  is therefore:

$$NAD_i = \sum_{j=1}^i \left( (i - j + 1) \times AD_j \right) \text{ per } i \text{ metres} \quad (4)$$

where  $i$  is the instant

$AD_j$  is the Angular Displacement at instant  $j$

By convention a positive Linear movement is in the upper or in the positive Y direction and a positive angular movement is anticlockwise.

The first picture in Figure 5 is referred to as Picture 0 and this is used to read the position of the Steel Beam and it is not observed by Reading Heads 1 to N-2. Just Reading Heads N-1 and N will be able to observe the Steel Beam. The position of the beam in these cameras is extracted and the values will be used to calculate the first *Linear* and *Angular* movements for the following picture which is Picture 1. For this reason no values are extracted from the last two Reading Heads in the last Picture because the Steel Beam has already passed through and the Reading Heads cannot see any part of the Steel Beam.

During the process, several 'sets of pictures' are taken depending on the length of the beam, and the Y co-ordinate is read after each picture has been analysed. After the beam passes completely into the field of view of all the cameras, the beam shape co-ordinates are calculated according to the stored Y co-ordinates of the beam as seen by the cameras.

For each Y co-ordinate extracted from the image at a certain instant, it is necessary to introduce the following negative corrections to obtain the beam shape:

- the summation of all the linear movements given by formula (1)
- the summation of the all angular displacements or formula (3), multiplied by the distance between camera 1 and the current camera
- the summation of all previous angular displacements, which is the Net Angular Displacements or formula (4), multiplied by the distance between the first and penultimate cameras which represents the length of the beam analysed by each set of pictures

The reason for correction **a)** is to compensate the Y value when the Steel Beam moves in the Y direction. Correction **b)** is to compensate for the current angular movement since the last picture and this is multiplied by the distance between Reading Head 1 and the Reading Head under consideration because the Angular Displacement is per metre. This is illustrated in Figure 7 as distance D per each camera.

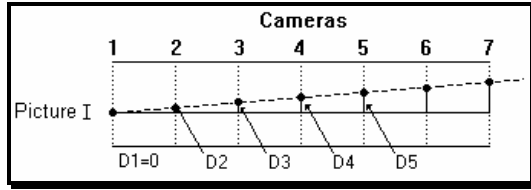

Figure 7 - Compensation for the current Angular Movement

Correction c) is equal for all the cameras in the same 'set of pictures' which occur at the same instant and it is necessary to compensate for all the angular movements which have occurred since the first picture as shown in Figure 6.

A general formula for the above corrections is given below:

$$YB_{i,j} = Y_{i,j} - \sum_{k=1}^i LM_k - Dist_{1,j} \times \sum_{k=1}^i AD_k - Dist_{1,N-1} \times \sum_{k=1}^{i-1} NAD_k \quad (5)$$

- Where:  $YB_{i,j}$  is the final Y co-ordinate of the beam shape in picture i by camera j
- $Y_{i,j}$  is the Y co-ordinate extracted from the screen in picture i by camera j
- $LM_k$  is the linear movement in picture k
- $Dist_{1,j}$  is the distance between cameras 1 and j
- $AD_k$  is the angular displacement per metre in picture k
- $Dist_{1,N-1}$  is the distance between cameras 1 and N-1
- $NAD_k$  is the Net angular displacement per metre in picture k
- N is the number of Video Cameras and j varies from 1 to N-2

After calculating the beam shape co-ordinates a graph is produced to show the overall profile of the Steel Beam and this result can then be compared with the relevant British Standards to check if the actual beam meets the required specification.

## 7. CASE STUDY

The example illustrated here is that of an ideal straight beam with linear and angular movement. Table 3 shows the results obtained from this particular test. The first row shows the video camera number and the distances between them in metres. The distance between camera 1 and camera 2 is 0.40 metres, the distance between camera 2 and camera 3 is 0.50 metres, etc. The other 6 rows represent the points extracted from the camera pictures for each camera. Thus, in Picture 0 only the last two cameras observed the beam and the values extracted are 6.0 and 6.4 millimetres. In Picture 1 all the cameras saw the beam and the values extracted per camera are shown in that row, i.e. 8.0 - 6.0 millimetres.

Cameras	1	2	3	4	5	6
Distances	0.4	0.5	0.1	0.6	0.4	

Y co-ordinates in millimetres

Picture	0				6.0	6.4
Picture	1	8.0	7.6	7.1	7.0	6.4
Picture	2	12.4	11.6	10.6	10.4	9.2
Picture	3	9.0	9.4	9.9	10.0	10.6
Picture	4	11.5	11.1	10.6	10.5	9.9
Picture	5	7.8	8.6	9.6	9.8	11.0

Table 3 - Example of image system readings with an ideal beam

With these values it is now possible to generate the following table with all the movements described. (All the values are in millimetres).

Picture	Linear Mov. Formula(1)	Sum of Linear Mov.	Angular Displacement Formula (3)	Net Angular Displacement Formula (4)
1	2.0	2.0	-2.0	-2.0
2	6.0	8.0	-1.0	-5.0
3	-0.2	7.8	3.0	-5.0
4	0.9	8.7	-2.0	-7.0
5	-2.1	6.6	3.0	-6.0

Table 4 - Table created with the formulae (1), (3) and (4)

After the mathematical technique had been applied, the resultant values in millimetres are as shown in Table 5:

	1 <sup>st</sup> cam.	2 <sup>nd</sup> cam.	3 <sup>rd</sup> cam.	4 <sup>th</sup> cam.
Picture 1	6.0	6.4	6.9	7.0
Picture 2	7.6	8.0	8.5	8.6
Picture 3	9.2	9.6	10.1	10.2
Picture 4	10.8	11.2	11.7	11.8
Picture 5	12.4	12.8	13.3	13.4

Table 5 - Calculated values of the Steel Beam Y co-ordinates

These numbers represent the Y co-ordinates of the beam from each picture after applying corrections for any angular movements of the beam. The corrections in this case mean that the beam in each picture has been transformed into the position seen in the first picture. Comparing the resultant values with the 'ideal' values, it can be observed that the difference is smaller than 0.08 millimetre per each 'set of pictures'. With these values the beam profile can be represented as shown in figure 8 with the X axis is in metres and the Y axis is in millimetres. Figure 8 represents the

beam profile as though it were always viewed from the first reading and it can be concluded that the beam is straight.

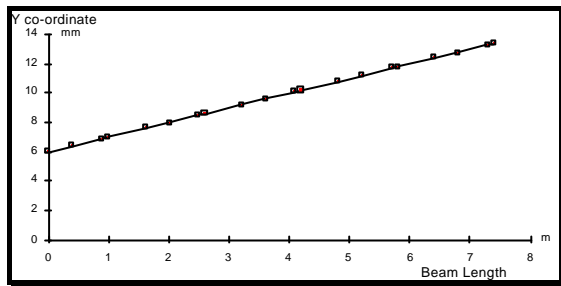

Figure 8 - Steel Beam profile after applying the mathematical technique

## 8. CONCLUSIONS

The principal advantage gained as a result of this work was the development of an image processing tool for the assessment of beam straightness. Both the image processing method and the calliper tool software have potential for other types of application. The main feature is that of extracting the edges of an image after teaching the computer to recognise the features of those edges. This tool proved to be sufficiently accurate for this machine and the results obtained are very reliable. This tool is also very simple to learn, easy to use, and it has performed very successfully under test conditions.

A mathematical technique to calculate all the co-ordinates was extracted from the pictures was successfully developed. The number of Reading Heads and the distance between them is a parameter which can be set by the user. The only limitation concerns the distance between the first and the second reading heads which has to be the same distance as that between the last two reading heads. These distances need to be accurately set and this is easy to carry out using a proper calibration procedure. The mathematical procedure is computer based and very fast. The problem of systematic and random errors has been fully investigated and these are small and therefore acceptable.

Sub-pixel resolution was achieved with success in the extraction of the Y co-ordinates by computer methods. This important technique makes it possible to improve the performance of the co-ordinates extracted instead of being limited to the discrete resolution of the video screen.

The mathematical technique and the image processing method were applied to a new Inspection Machine which was built and currently being commissioned by Integral Vision Ltd and Joseph Rhodes Ltd as British

Steel Research. Finally, it is noted that the system will provide the steel industry with a total inspection and this will rapidly lead to the concept of a total quality management system.

## ACKNOWLEDGEMENTS

First, I would like to thank my wife for her strong support and help on the writing of this paper and my parents and sister for encouraging me to do this work. My respectful thanks to Prof. Antonio Lencastre Godinho (Universidade Portucalense, Porto, Portugal) for his enormous encouragement. I would like to express my gratitude to Dr R.S. McMaster for their supervision and guidance. Thanks also to Integral Vision Ltd' (Bedford, UK) for their support, and to the team involved in this project, like Dr. Frederico Magalhaes, Frank Meyer and Howard Chan.

## REFERENCES

- [1] ANACLETO, S.C., "*Dynamic Assessment of Beam Straightness by Non-Contact Means*" Thesis at Cranfield Institute of Technology, England, 1991.
- [2] PUGH A., "*Robot Vision*" International Trends in Manufacturing Technology, IFS (Publications) Ltd., ISBN 0-903608-32-4, UK, 1983.
- [3] RIBEIRO, A. F. M. and MEYER, F., "*Development of Image Processing Tools for the Measurement of Beam Straightness*", 3rd International Symposium on Measurement and Control in Robotics, Torino, Italy, 1993.
- [4] ZUECH N. and MILLER, R. K., "*Machine Vision*" The Fairmont Press, ISBN 0-88173-017-3, USA, 1987.