

# **i9MASKS Workshop: Extended Abstracts**

Rui A. Lima  
Senhorinha Teixeira  
Graça Minas  
Cristina Rodrigues  
Violeta Carvalho





UMinho Editora  
Atas



## **i9MASKS Workshop: Extended Abstracts**

EDITORS  
Rui A. Lima  
Senhorinha Teixeira  
Graça Minas  
Cristina Rodrigues  
Violeta Carvalho

EDITION  
Universidade do Minho  
PAGINAÇÃO  
Carlos Sousa – Bookpaper  
LOCAL DE EDIÇÃO Braga 2022  
ISBN 978-989-8974-32-7

DOI <https://doi.org/10.21814/uminho.ed.39>

Os conteúdos apresentados (textos e imagens) são da exclusiva responsabilidade dos respetivos autores.  
© Autores / Universidade do Minho – Esta obra encontra-se sob a Licença Internacional Creative Commons Atribuição 4.0

UMINHO EDITORA

# i9MASKS Workshop: Extended Abstracts



**FCT**  
Fundação para a Ciência e a Tecnologia  
MINISTÉRIO DA EDUCAÇÃO E CIÊNCIA

Universidade do Minho  
Escola de Engenharia



CENTROALGORITMI





The pandemic caused by COVID-19 has spread quickly and has caused a great number of deaths worldwide. Due to the progressively increase of infected patients, countries have used preventive measures against this pandemic, such as the use of face masks. The masks have become indispensable to control both public and personal health, by reducing the transmission and spreading rate of the virus. Nevertheless, the traditional masks hide our facial expressions and emotions, and also communication obstacles. In this way, the project, i9MASKS (supported by the Grant-in-Aid “Verão com Ciência” approved by Fundação para a Ciência e Tecnologia (FCT)), aimed to develop transparent facial masks by using polydimethylsiloxane (PDMS) and as a result to reduce not only the transmission and spreading rate of the new coronavirus SARS-CoV-2 but also to minimize the social and environmental impact of the masks.

Besides the transparency, the material (PDMS) used to make the masks, has unique and advantageous properties, such as biocompatibility, gas permeability, flexibility and supports autoclaving processes allowing its reuse. To develop these PDMS masks, students and researchers have worked together and acquired multidisciplinary and innovative knowledge at a wide variety of fields, such as computer-aided design, rapid prototyping and 3D printing, microfabrication and microfluidics techniques, numerical simulations, microelectronics and optics, and nanotechnology and nanoparticle synthesis. From this project, several outstanding research works have been performed including both experimental and numerical investigations, which were later presented at the i9MASKS workshop.

This book represents a collection of scientific extended abstract that were presented at the i9Masks workshop in October 2020, at the School of Engineering of Minho University, in Guimarães, Portugal.

### **The Editors**

Rui A. Lima  
Senhorinha Teixeira  
Graça Minas  
Cristina Rodrigues  
Violeta Carvalho



Foreword	5
Organizing and Scientific Committee	8
<b>Extended Abstracts</b>	9
<b>Manufacturing process of PDMS facial mask</b>	11
Filipe Barbosa, Andrews Souza, Carlos Faria, João Ribeiro & Rui Lima	
<b>Fabrication of mask in PDMS for SARS-CoV-2 (COVID-19)</b>	15
Denise Carvalho, Tiago Vale, Graça Minas & Rui Lima	
<b>Cooling system for a PDMS mask</b>	19
Ângela Meireles, João Fernandes, Vânia Pinto & Luís Gonçalves	
<b>Characterization of PDMS' multiple properties</b>	24
Ana Rita Simões, Rita Gomes, Maria Sabrina Souza, Delfim Soares & Rui Lima	
<b>PDMS: an analysis on its mechanical properties and transparency</b>	28
Ana Gomes, João Magalhães, Maria Souza, Delfim Soares, Senhorinha Teixeira & Rui Lima	
<b>Mechanical properties of pure PDMS and the combination between the textile fabric with PDMS</b>	32
Flaminio Sales, Andrews Souza, João E. Ribeiro & Rui A. Lima	
<b>How can we make breathable PDMS ?</b>	36
Ana Cacho, Renata Maia, Rosa Monteiro, R. Rodrigues, G. Minas, J. Miranda, D. Pinho & R. Lima	
<b>UV-C sterilization of the PDMS</b>	40
Inês Miranda, Inês Castro, V. C. Pinto, P.J. Sousa & G. Minas	
<b>Study of the incorporation of microchannels in PDMS</b>	44
Renata Diehl, Rui Lima & Susana O. Catarino	
<b>Numerical simulation: study on the path of expelled and expired water vapor particles</b>	48
Inês Teixeira, Violeta Carvalho, Senhorinha Teixeira & Nélson Rodrigues	
<b>Numerical simulation: a study of porosity and space</b>	52
Bernardo Faria, Cláudia Oliveira, Violeta Carvalho, Senhorinha Teixeira & Nélson Rodrigues	
<b>Simulation study of SARS-CoV-2 (COVID-19) spread by breathing, coughing and sneezing</b>	56
Filipe Ferreira & Susana Catarino	
I9MASKS poster, website and videos	60



## Organizing and Scientific Committee

Rui A. Lima, MEtRICs, Universidade do Minho  
Senhorinha Teixeira, ALGORITMI, Universidade do Minho  
Graça Minas, CMEMS, Universidade do Minho  
Cristina Rodrigues, ALGORITMI, Universidade do Minho  
Violeta Carvalho, MEtRICs, Universidade do Minho

# **Extended Abstracts**



# Manufacturing process of PDMS facial masks

Filipe Barbosa<sup>1</sup>, Andrews Souza<sup>2</sup>, Carlos Faria<sup>2</sup>, João Ribeiro<sup>2</sup>, Rui Lima<sup>1,\*</sup>

<sup>1</sup> *Mechanical Engineering Department, University of Minho, Campus de Azurém, Guimarães, Portugal*

<sup>2</sup> *Polytechnic Institute of Bragança, Bragança, Portugal*

\* [rl@dem.uminho.pt](mailto:rl@dem.uminho.pt)

## Introduction

At the present time, the acute respiratory syndrome (SARS-CoV-2) that causes COVID-19, was declared as a global pandemic by the World Health Organization (WHO) on January 31, 2020. This disease is characterized by causing serious infections of the human respiratory tract [1]. Its transmission can be through direct contact from person to person, by touching contaminated surfaces, inhaling larger respiratory droplets or by air with the inhalation of small airborne droplets, thus being able to be transmitted over great distances without the need for close contact with the infected person, making transmission much more effective [2].

There is currently no defined treatment and the vaccine is in the study phase [3], a number of measures have been applied to slow down contagion, including hand and face hygiene, environment sterilization, social distance and the use of personal protective equipment (PPE) [4]. Among these PPE, masks have become one of the indispensable pieces. However, current models hinder interpersonal communication, cause environmental problems, in addition to causing skin irritation and discomfort [5]. Matthew Purdy et al [6] showed that the comfort of the masks is the primary factor for greater public adherence to the use of masks in complying with infection control measures.

Therefore, in view of this scenario, this work aims to develop transparent, reusable and biocompatible masks, made of polydimethylsiloxane (PDMS) [7][8]. For the manufacture, the used process consisted of designing the mold (matrix and positive) by 3D CAD software (Fusion 360) and printing them on a 3D printer. After printing the models, the matrix was used to make the mold in two parts of polyurethane resin (PU), and then the PDMS was poured by gravity. After the silicone curing, the masks were demoulded to obtain the final model in PDMS. To improve hydrophobic characteristics of the final model was implemented a glycerin-based surface treatment on PDMS. This treatment makes the PDMS surface hydrophilic and prevents condensation inside the mask. The processes used proved to be effective for the manufacture of transparent, reusable, and biocompatible masks suitable not only for the use of health professionals but for the general population.

## Materials and methods

This chapter will present the sequence of the entire process to obtain PDMS masks (Figure 1), which includes the development of virtual models, rapid prototyping, the bipartite molds manufacturing and the manufacture of PDMS masks.

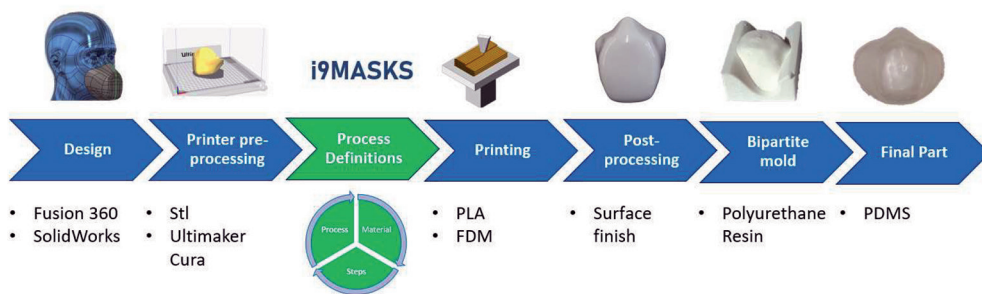

**Figure 1**  
Steps of the manufacturing process.

## Results and Discussion

The prototype obtained after curing the PDMS is shown in Figure 2(a). With the prototypes ready and knowing that the PDMS has a low air permeability, filters were placed on the side of the mask (Figure 2 (b)) and for a better fit, a wire positioner was placed in the nose area (Figure 2(c)).

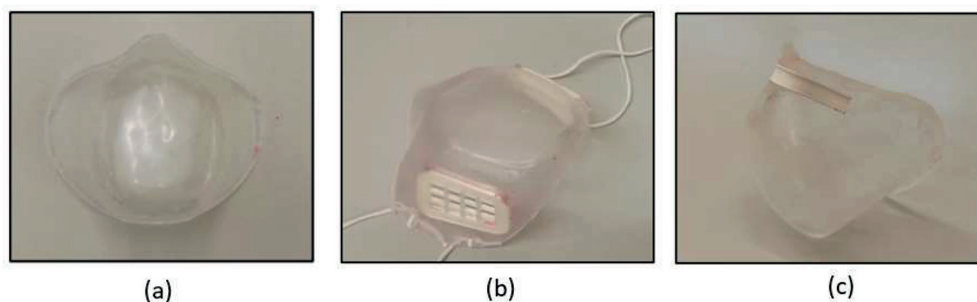

**Figure 2**  
Masks in PDMS. (a) prototype after curing; (b) with side filters; (c) with wire positioner in the nose area.

## Conclusions

To slow down contagion between people, one of the measures that WHO recommended was the use of masks, but the most used models difficult the interpersonal communication, causing discomfort and irritation. Thus, this work presented a manufacturing process that uses bipartite mold to model the PDMS and so obtain transparent, biocompatible, and reusable masks. The masks obtained by this process, proved to be effective and appropriate not only for the use of health professionals but for the general population.

## Acknowledgment

Andrews Souza and Filipe Barbosa acknowledge the scholarship granted by FCT. This work was supported in part by the projects NORTE-01-0145-FEDER-028178, NORTE-01-0145-FEDER-029394 and NORTE-01-0145-FEDER-030171 funded by NORTE 2020 Portugal Regional Operational Program under PORTUGAL 2020 Partnership Agreement through the European Regional Development Fund and the Fundação para a Ciência e Tecnologia (FCT). The authors also acknowledge the partial financial

support by the projects UIDB/EEA/04436/2020 and UIDB/EMS/04077/2020 and UIDB/00319/2020 from FCT.

## References

- [1] A. S. Fauci, H. C. Lane, and R. R. Redfield, "COVID-19 – Navigating the uncharted," *N. Engl. J. Med.*, vol. 382, no. 13, pp. 1268-1269, 2020.
- [2] L. Morawska et al., "How can airborne transmission of COVID-19 indoors be minimised?," *Environ. Int.*, vol. 142, no. May, 2020.
- [3] S. Pagliusi et al., "Emerging manufacturers engagements in the COVID-19 vaccine research, development and supply," *Vaccine*, vol. 38, no. 34, pp. 5418-5423, 2020.
- [4] J. Xiao et al., "Nonpharmaceutical Measures for Pandemic Influenza in Non-healthcare Settings – Personal Protective and Environmental Measures - Volume 26, Number 5 – May 2020 – Emerging Infectious Diseases journal – CDC," *Emerg. Infect. Dis.*, vol. 26, no. 5, pp. 967-975, 2020.
- [5] F. Chao, "Face mask designs following novel Coronavirus," vol. 9, pp. 31-35, 2020.
- [6] M. Purdy, "Comparison of facemask characteristics with user assessment of comfort", University of Iowa, 2019.
- [7] A. Victor, J. Ribeiro, and F. F. Araújo, "Study of PDMS characterization and its applications in biomedicine: A review," *J. Mech. Eng. Biomech.*, vol. 4, no. 1, pp. 1-9, 2019.
- [8] D. Pinho et al., "An In Vitro Experimental Evaluation of the Displacement Field in an Intracranial Aneurysm Model," Flores, Viadero (Eds.), *New Trends Mech. Mach. Sci. Mech. Mach. Sci. Springer Int.*, vol. 24, pp. 261-268, 2015.

# Fabrication of mask in PDMS for SARS-CoV-2 (COVID-19)

Denise A. M. Carvalho<sup>1,\*</sup>, Tiago Vale<sup>2</sup>, Graça Minas<sup>1</sup>, Rui Lima<sup>3,4</sup>

<sup>1</sup> *Center for MicroElectromechanical Systems (CMEMS-UMinho), University of Minho, Campus de Azurém, Guimarães, Portugal*

<sup>2</sup> *Mechanical Engineering Department, University of Minho, Campus de Azurém, Guimarães, Portugal*

<sup>3</sup> *Mechanical Engineering and Resource Sustainability Center (MEtRICs), University of Minho, Campus de Azurém, Guimarães, Portugal*

<sup>4</sup> *CEFT, Faculty of Engineering of the University of Porto, Rua Dr. Roberto Frias, Porto, Portugal*

\* *denisemotacarvalho@gmail.com*



## Introduction

The new coronavirus SARS-CoV-2 (COVID-19) belongs to the family Coronaviridae and was first identified in December 2019 in China, in the city of Wuhan [1]. With the spread of this virus, there was an urgent need to minimize its propagation. Consequently, it was suggested to the world population to use masks, in order to control/minimize the proliferation of the virus made through the projection of droplets, which although invisible to the naked eye, are projected when a person sneezes, coughs, or even speaks [2, 3].

With the frequent use of a mask, another necessity was identified; to have transparent masks that allow people to identify each other. This need arose due to situations such as health professionals from hospitals and health centers, in which patients were unable to identify the person who was treating them, as well as the health professionals were unable to identify themselves. To solve these problems the project i9MASKS proposes the creation of transparent masks using polymeric materials such as Polydimethylsiloxane (PDMS) [4–7].

Throughout this project, some of the properties of this polymer were studied and some manufacturing tests were carried out, so that at the end of the project, it was possible to develop a functional mask prototype that could be used by the target public mentioned above or even by other people who identify the same necessity.

## Materials and methods

Several steps were performed to achieve a functional mask prototype. The first step was modelling the mask mold using the Autodesk Fusion 360 software. A planar mold for the mask was made for easier development of the TNT filters positioning. After the 3D model, a 3D printer, Ultimaker 2+, was used to print the mold in PLA (Polylactic Acid), so then the PDMS could be leaked and cured, using a dryer at a temperature of 40°C. In the end, the two sides of the prototype, were joined by a PDMS wire so we could have a physical model of the mask that could be used and tested.

## Results and discussion

After several experiments, it was possible to achieve a first 3D mask prototype in PDMS with a TNT filter incorporated and with elastics to support it, as can be seen in figure 1a. To achieve this prototype, several studies were done for an ideal PLA mold to leak the PDMS and thus have the prototype. Figure 1b shows the mold used for the prototype.

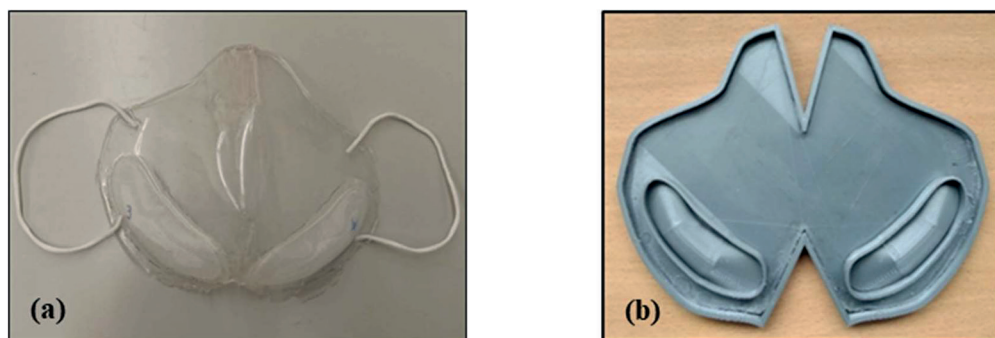

**Figure 1**  
a) First 3D mask prototype in PDMS with a TNT filter incorporated and with elastics; b) mold in PLA for the prototype mask.

In this prototype it was possible to incorporate TNT filters, an important and innovative step for the mask, as one of the main objectives is to have a transparent mask, but that is comfortable for the user in terms of breathability. The incorporation of filters will allow a better air flow inside the mask, preventing the formation of condensation and thus avoiding discomfort. One of the problems that still exists when incorporating these filters is the excessive absorption of PDMS during the mask cure process. For this purpose, PLA rings were developed to be placed in the filter area (figure 2) and to prevent the unwanted absorption of the PDMS by the filter.

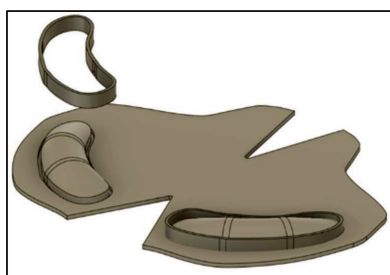

**Figure 2**  
Mold with PLA rings for the prototype mask.

## Conclusions

The obtained transparent mask prototype shows good characteristics such as transparency and biocompatibility, since the PDMS is a type of biocompatible silicone. With future experimental advances, it is believed that is possible to have a transparent 3D mask, with good breathability and, especially, this mask is reusable through its hygiene and only its filters are replaced, thus avoiding waste as happens in the present reality.

## Acknowledgment

Denise A. M. Carvalho and Tiago Vale acknowledge the scholarship granted by FCT. This work was supported in part by the projects NORTE-01-0145-FEDER-028178, NORTE-01-0145-FEDER-029394 and NORTE-01-0145-FEDER-030171 funded by NORTE 2020 Portugal Regional Operational Program under PORTUGAL 2020 Partnership Agreement through the European Regional Development Fund and the Fundação para a Ciência e Tecnologia (FCT). The authors also acknowledge the partial

financial support by the projects UIDB/EEA/04436/2020 and UIDB/EMS/04077/2020 and UIDB/00319/2020 from FCT.

## References

- [1] P. Zhou et al., "A pneumonia outbreak associated with a new coronavirus of probable bat origin," *Nature*, vol. 579, no. 7798, pp. 270-273, 2020, doi: 10.1038/s41586-020-2012-7.
- [2] T. Dbouk and D. Drikakis, "On coughing and airborne droplet transmission to humans," *Phys. Fluids*, vol. 32, no. 5, 2020, doi: 10.1063/5.0011960.
- [3] B. Blocken, F. Malizia, T. van Druenen, and T. Marchal, "Towards aerodynamically equivalent COVID19 1.5 m social distancing for walking and running," *Urban Phys.*, p. 12, 2020.
- [4] D. Pinho, B. N. Muñoz-Sánchez, C. F. Anes, E. J. Vega, and R. Lima, "Flexible PDMS microparticles to mimic RBCs in blood particulate analogue fluids," *Mech. Res. Commun.*, vol. 100, pp. 18-20, 2019, doi: 10.1016/j.mechrescom.2019.103399.
- [5] V. Faustino, S. O. Catarino, R. Lima, and G. Minas, "Biomedical microfluidic devices by using low-cost fabrication techniques: A review," *J. Biomech.*, vol. 49, no. 11, pp. 2280-2292, 2016, doi: 10.1016/j.jbiomech.2015.11.031.
- [6] R. Lima et al., "In vitro blood flow in a rectangular PDMS microchannel: Experimental observations using a confocal micro-PIV system," *Biomed. Microdevices*, vol. 10, no. 2, pp. 153-167, 2008, doi: 10.1007/s10544-007-9121-z.
- [7] A. Mata, A. J. Fleischman, and S. Roy, "Characterization of Polydimethylsiloxane (PDMS) Properties for Biomedical Micro/Nanosystems," *Biomed. Microdevices*, vol. 7, no. 4, pp. 281-293, 2005, doi: 10.1007/s10544-005-6070-2.

# Cooling system for PDMS masks

A. Meireles<sup>1,\*</sup>, J. Fernandes<sup>1,\*</sup>, V. C. Pinto<sup>1</sup>, L. M. Gonçalves<sup>1</sup>

<sup>1</sup> *Center for MicroElectromechanical Systems (CMEMS-UMinho), University of Minho, Campus de Azurém, Guimarães, Portugal*

\* [a78343@alunos.uminho.pt](mailto:a78343@alunos.uminho.pt)/[a78831@alunos.uminho.pt](mailto:a78831@alunos.uminho.pt)

## Introduction

Nowadays, the individual protective masks represent a crucial tool in decreasing the spread of high-risk pandemic infection, especially the coronavirus disease (COVID-19) 1,2. However, its intensive use increases the amount of heat trapped beneath the mask and consequently causes an increase in the facial skin temperature and in some cases cutaneous irritations. Furthermore, a relevant discomfort when wearing protective face masks is reported by many people. Thus, the possibility of creating a system that allows reducing the heat in the mask is very important for increase the comfort in its use.

In this work, it is studied and implemented a new approach of cooling system integrated on individual protection mask using a miniaturized temperature sensor and a fan. The developed electronic circuit to control and actuate is also presented.

## Materials and methods

The implemented cooling system comprises a temperature sensor, a fan and an electronic circuit (Figure 1). The operation principle of this system is based on the activation of a fan when the temperature reaches 30°C inside the mask, promoting cooling. After cooling, and the temperature drops to 30°C, the fan switches off. This circuit consists of using an ON-OFF controller and an ON-OFF actuator 3,4. Basically, the ON-OFF controller, measures the temperature inside the mask and activate the ON-OFF actuator. The ON-OFF controller consists of a temperature sensor (TMP36) that has a sensibility of 10mV/°C<sup>5</sup>. The potentiometer was adjusted to a temperature that was already annoying (it was designed for a temperature of 30°C), and when the temperature sensor reaches this temperature, it activated the fan, which is under the influence of the ON-OFF actuator.

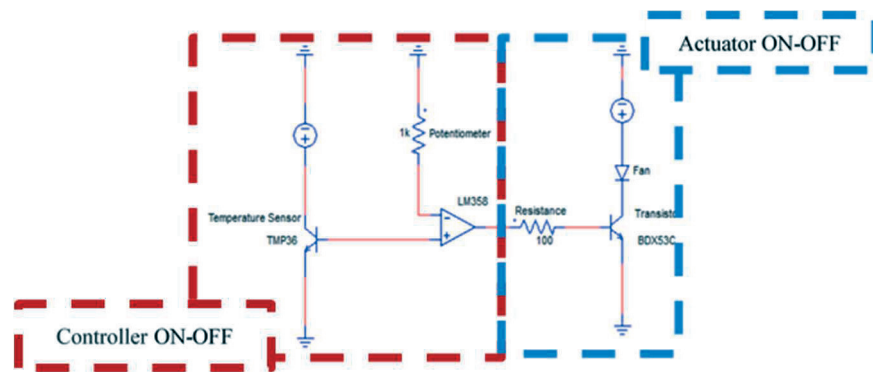
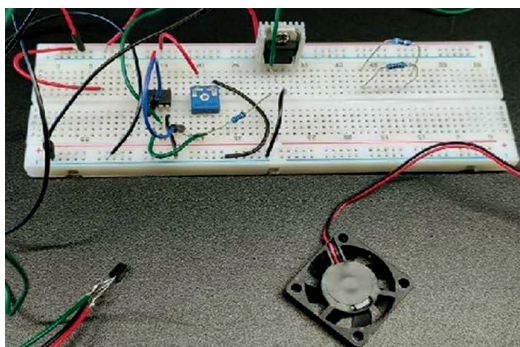

**Figure 1**  
Cooling circuit to be implemented in the individual protection mask.

## Results and discussion

The developed cooling system was initially validated out of a face mask and the electronic circuit was assembled on the breadboard (figure 2). The first validation was made using the fingers to promote the heating of the temperature sensor and

evaluate the performance of the system. In this stage, a temperature of 30°C was defined to activate the fan (Figure 3). Thus, when two fingers were placed over the temperature sensor and reach the desired temperature, the activation of the fan was successfully verified (Figure 3). When the fingers are removed and the temperature falls below 30°C, the fan turns off. The second validation was carried out within a prototype of a 3D printed mask to simulate a real scenario (Figure 4). After validating the circuit, a PCB (Printed Circuit Board) of small size was developed to facilitate the integration in the mask. The PCB prototype is shown in figure 5 a) and b).



**Figure 2**  
Cooling circuit  
assembled on a  
breadbord.

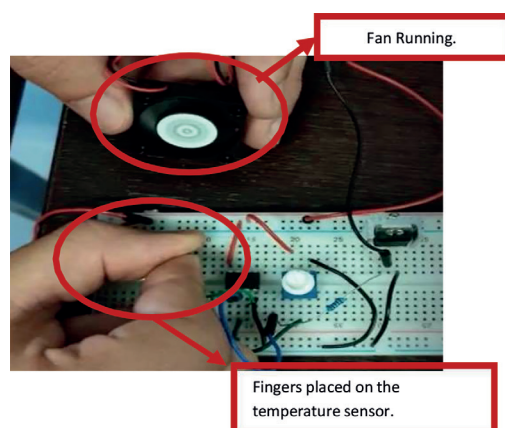

**Figure 3**  
First test performed  
with the cooling circuit.

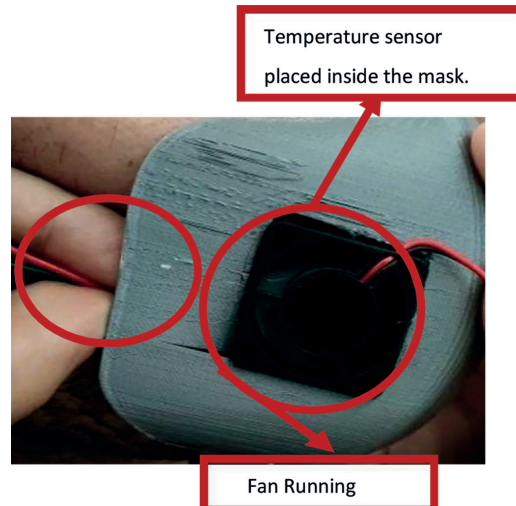

**Figure 4**  
Second test performed with the cooling circuit.

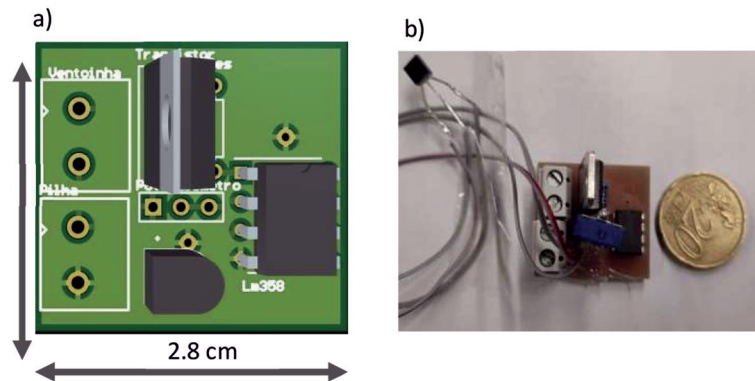

**Figure 5**  
(a) 3D view of the developed PCB. (b) First PCB Prototype.

## Conclusions and future work

In this work, a cooling system for integrating into face masks was successfully developed using a simple and low-cost approach. Some future improvements could be made, especially to make the PCB smaller using components of SMD character (Surface Mounted Device). Furthermore, it is needed to study an efficient way of integrating all components inside the mask without compromising its functionality.

## Acknowledgment

Ângela Meireles and João Fernandes acknowledge the scholarship granted by FCT. This work was supported in part by the projects NORTE-01-0145-FEDER-028178, NORTE-01-0145-FEDER-029394 and NORTE-01-0145-FEDER-030171 funded by NORTE 2020 Portugal Regional Operational Program under PORTUGAL 2020 Partnership Agreement through the European Regional Development Fund and the Fundação para a Ciência e Tecnologia (FCT). The authors also acknowledge the partial financial support by the projects UIDB/EEA/04436/2020 and UIDB/EMS/04077/2020 and UIDB/00319/2020 from FCT. This work was co-financed by Programa Operacional Regional do Norte (NORTE2020), through Fundo Europeu de Desenvolvimento Regional (FEDER), Project NORTE-01-0145-FEDER-000032 – NextSea.

## References

- [1] Ronellenfitsch, H. & Katifori, E. The Phenotypes of Fluctuating Flow: Development of Distribution Networks in Biology and the Trade-off between Efficiency, Cost, and Resilience. arXiv:1707, (2017).
- [2] Chu, D. K. et al. Physical distancing, face masks, and eye protection to prevent person-to-person transmission of SARS-CoV-2 and COVID-19: a systematic review and meta-analysis. *Lancet* 395, 1973-1987 (2020).
- [3] Laboratorial, G. D. P. Controlo On - Off e Proporcional. 0–19.
- [4] Garrido, P. Elementos de Controlo Automático. Licença Creat. Commons Attrib. Share Alike (2010).
- [5] Analog Devices. Tmp35/Tmp36/Tmp37. Analog Device 1-2 (2008).



# Characterization of PDMS' multiple properties

Ana Rita Simões<sup>1</sup>, Rita Gomes<sup>1</sup>, Maria Sabrina Souza<sup>2</sup>, Delfim Soares<sup>2</sup>, Rui Lima<sup>3</sup>

<sup>1</sup> *Mechanical Engineering Department, University of Minho, Campus de Azurém, Guimarães, Portugal*

<sup>2</sup> *Center for MicroElectromechanical Systems (CMEMS-UMinho), University of Minho, Campus de Azurém, Guimarães, Portugal*

<sup>3</sup> *Mechanical Engineering and Resource Sustainability Center (MEtRICs), University of Minho, Campus de Azurém, Guimarães, Portugal*

## Introduction

Polydimethylsiloxane (PDMS) has been the subject of study by several researchers over the last few years due to its unique properties, such as gas permeability, biocompatibility, high mechanical elasticity and chemical inertness that make this polymer an excellent material in several applications [1]. In addition, it is a low-cost and transparent polymer with a fast simple fabrication [2]. The objective of this work, developed in the scope of the "i9MASKS" project, has focused on the assessment of some physical-chemical and mechanical properties of the PDMS, through the following tests: spectrophotometry; wettability test; DMA (Dynamic Mechanical Analysis). As an alternative to the PDMS, a second material was characterized, the HB SKIN 30 silicone, using the spectrophotometry technique, due to its low cost.

## Materials and methods

### Sample preparation

PDMS was purchased as a kit of two components (Sylgard 184, Dow Corning Corporation), prepolymer base and crosslinker. For synthesizing PDMS, the two parts were mixed and cured according to the ratios and curing temperatures discussed below. First, calculated amounts of prepolymer base and curing agent were weighted and mixed manually for 3 min. Next, the mixture was poured into a mold of desirable shape for each test. The mixture was then vacuum degassed for 30 min to remove any entrapped air. Finally, the samples were cured at temperatures and times specified earlier.

### Spectrophotometry test

The spectrophotometry tests were performed on a spectrophotometer (UV-2600, SHIMADZU) across a wavelength of 200-800 nm. The PDMS samples (55×23×2 mm<sup>3</sup>) were prepared with different mix ratios (5:1, 10:1, 15:1 and 20:1) and curing temperatures (40°C for 24h, 60°C for 2h, 100°C for 45 min and 140°C for 25 min). Differently, the HB SKIN 30 samples (55×23×2 mm<sup>3</sup>) were prepared with a ratio of 1:1 at room temperature.

### Wettability test

The wetting contact angles of PDMS samples were measured using a contact-angle microscope (Data OCA 15 plus, dataphysics). Deionized water droplets with 5 mL of volume were deposited on each sample surface to investigate the contact angle between PDMS and liquid. The samples (55×23×2 mm<sup>3</sup>) were prepared with different mix ratios (5:1, 10:1, 15:1 e 20:1) and curing temperatures (40°C for 24h, 100°C for 45 min and 140°C for 25 min).

## DMA test

PDMS viscoelastic properties were assessed with dynamic mechanical spectroscopy (DMA Q 800, TA Instruments) that performs forced oscillation tests. A sample ( $33 \times 6 \times 2$  mm<sup>3</sup>) was subjected to small sinusoidal oscillations in the longitudinal direction with a maximum amplitude of 1.3 mm at a constant frequency of 1 Hz for a temperature of, approximately, 27°C. The samples were prepared with a constant mix ratio of 10:1 and different curing temperatures (60°C for 2h, 80°C for 55 min, 100°C for 45 min, 120°C for 35 min and 140°C for 25 min).

## Results and discussion

### Spectrophotometry test

The transmittance of the PDMS assumed values between 75% and 85% for wavelengths between 400 nm and 750 nm, regardless of the variation in the curing temperature of the samples or their mix ratio. As for the HB SKIN 30 silicone, considering the same wavelength range, it was found that its transmittance varied between 39% and 63%.

### Wettability test

The contact angle between each PDMS sample and the water droplets were within a range of 90° and 150°. Thus it can be concluded that the polymer has a hydrophobic surface [3].

### DMA test

The viscoelastic properties of PDMS (Figure 1) measured were storage modulus ( $E'$ , elastic portion of energy), loss modulus ( $E''$ , viscous portion of energy) and loss tangent ( $\tan \delta = E''/E'$ ).

**Figure 1**  
Viscoelastic properties of PDMS. (a) The storage modulus ( $E'$ ), versus curing temperature; (b) The loss modulus ( $E''$ ), versus curing temperature and (c) The loss tangent ( $\tan \delta$ ) versus curing temperature.

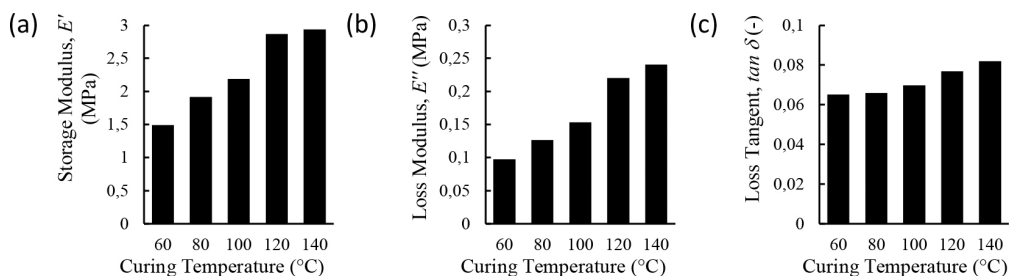

The increase in curing temperature results in an increase of storage modulus, loss modulus, and loss tangent. Since the storage modulus is much higher than the loss modulus, PDMS presents mostly an elastic behaviour.

## Conclusions

During the “i9MASKS” project, some physicalchemical and mechanical properties of PDMS were evaluated, such as its transmittance, resistance of its surface to wettability and viscoelastic properties (storage modulus, loss modulus and loss tangent). The results have shown that PDMS is a highly elastic material with low energy dissipation, with excellent transparency characteristics, whose surface is hydrophobic. Regarding the HB Skin 30 silicone, it was found that it is a translucent material and, therefore, it is not a viable alternative to PDMS.

## Acknowledgments

Ana Rita Simões and Rita Gomes acknowledge the scholarship granted by FCT. This work was supported in part by the projects NORTE-01-0145-FEDER-028178, NORTE-01-0145-FEDER029394 and NORTE-01-0145-FEDER-030171 funded by NORTE 2020 Portugal Regional Operational Program under PORTUGAL 2020 Partnership Agreement through the European Regional Development Fund and the Fundação para a Ciência e Tecnologia (FCT). The authors also acknowledge the partial financial support by the projects UIDB/EEA/04436/2020 and UIDB/EMS/04077/2020 from FCT.

## References

- [1] A. Mata, A. J. Fleischman, and S. Roy, “Characterization of Polydimethylsiloxane (PDMS) Properties for Biomedical Micro/Nanosystems,” *Biomed. Microdevices*, vol. 7, no. 4, pp. 281–293, Dec. 2005, doi: 10.1007/s10544-005-6070-2.
- [2] I. D. Johnston, D. K. McCluskey, C. K. L. Tan, and M. C. Tracey, “Mechanical characterization of bulk Sylgard 184 for microfluidics and microengineering,” *J. Micromechanics Microengineering*, vol. 24, no. 3, 2014, doi: 10.1088/0960-1317/24/3/035017.
- [3] J. Guancheng, “Effect of Gas Wettability on the Surface Properties of Rocks,” in *Gas Wettability of Reservoir Rock Surfaces with Porous Media*, Elsevier, 2018, pp. 121–162.

# PDMS: An analysis on its mechanical properties and transparency

Ana C. Gomes<sup>1</sup>, João A. Magalhães<sup>1</sup>, Maria Sabrina Souza<sup>1</sup>, Delfim Soares<sup>2</sup>,  
Senhorinha Teixeira<sup>3</sup>, Rui Lima<sup>4\*</sup>

<sup>1</sup> *Mechanical Engineering Department, University of Minho, Guimarães, Portugal*

<sup>2</sup> *CMEMS, University of Minho, Mechanical Engineering Department, Guimarães, Portugal*

<sup>3</sup> *ALGORITMI, University of Minho, Campus de Azurém, Guimarães, Portugal*

<sup>4</sup> *Mechanical Engineering and Resource Sustainability Center (MEtRICs), University of Minho, Campus de Azurém, Guimarães, Portugal*

\* [rl@dem.uminho.pt](mailto:rl@dem.uminho.pt)

## Introduction

Within the scope of the summer project “i9Masks”, financed by the FCT (Fundação para a Ciência e Tecnologia) in partnership with University of Minho, it was planned to measure the mechanical properties of Polydimethylsiloxane (PDMS), with the aim of making transparent, biocompatible and reusable masks. PDMS is an elastomer which several applications in the biomedical sector such as lenses, implants, and is widely used in microfluidics due to its ease of manufacture, biocompatibility, transparency and having a lower cost when compared to previous processes that uses glass [1, 2]. Knowing that the properties of the PDMS can be changed according to the concentration of the prepolymer and the curing agent [3], samples were produced at different temperatures and ratios. The specimens were then subjected to tests to verify the storage modulus and loss modulus by means of Dynamic Mechanical Analysis (DMA) [4]. Qualitative tests of transparency, measurement of calorific value and the percentage composition of the elements that make up the material were also carried out. Through these analyses, it can be concluded that the PDMS has an elastic behaviour, has good optical properties and a high calorific value.

## Materials and methods

The first tests carried out consisted in analysing the viscoelastic properties of PDMS using the DMA (Figure 1a). Several samples were produced with the ratios of: 5:1; 10:1; 15:1 and 20:1 at two different curing temperatures (25°C and 40°C), totalizing eight different samples. The transparency of the specimens produced at a room temperature was tested using a qualitative method. The percentage composition of elements of the PDMS was analysed in a multi-element analyser (Figure 1b), while its calorific value was measured using a calorimeter (Figure 1c).

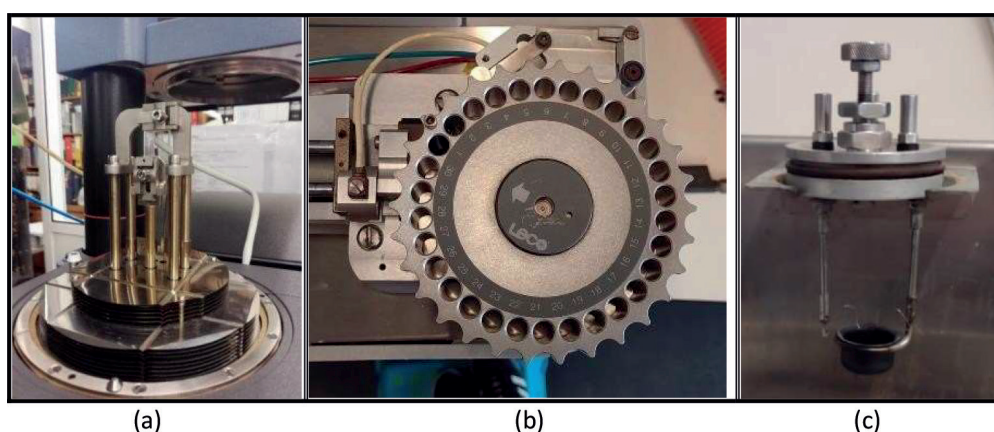

**Figure 1**  
Equipment used in the tests. (a) DMA; (b) Multi-element analyser and (c) Base of the calorimeter.

## Results and discussion

Figure 2 shows that the values of the storage modulus (elastic component) are higher than the loss modulus (viscous component) values, for both temperatures analysed,

which allows us to conclude that PDMS has a high elasticity, being consistent with the literature. According to the transparency analysis, it was observed that regardless the ratios, the PDMS showed a good transparency (Fig. 3).

**Figure 2**

Values obtained from the experimental data of the storage modulus and loss modulus for the analysed samples (a) at 25°C and (b) at 40°C.

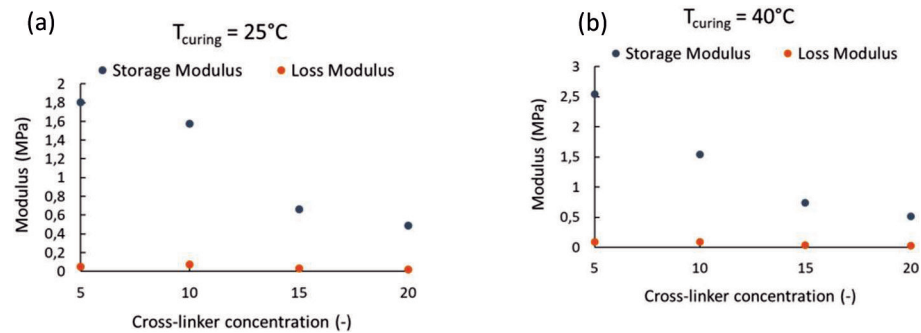

**Figure 3**

PDMS samples with different cross linker concentration: (a) 5:1; (b) 10:1; (c) 15:1 and (d) 20:1, cured at room temperature.

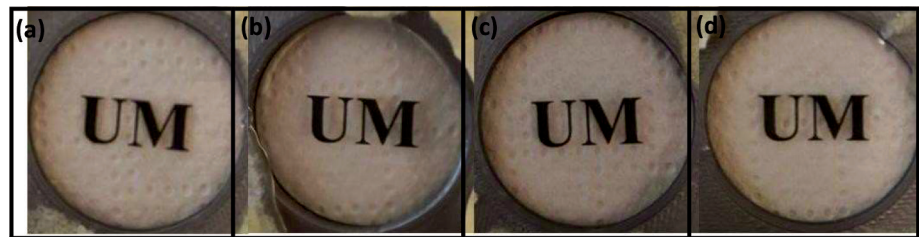

In Figure 4, it is possible to see the elementary chemical composition of the PDMS (Figure 4a), as well as the value of its calorific value (Figure 4b).

**Figure 4**

(a) Percentage of the analysed elements in PDMS. (b) Calorific value of analysed sample of PDMS.

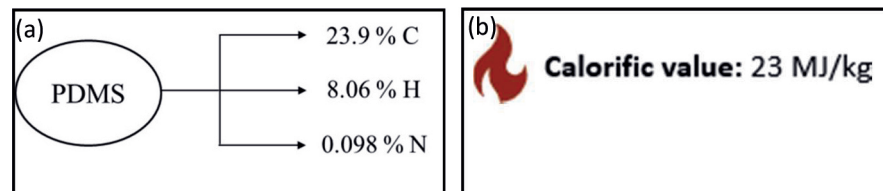

## Conclusions

According to the obtained results, we can conclude that the PDMS has a predominantly elastic behaviour, as well as excellent optical properties (transparency). It was also possible to notice that, due to its carbon composition, it has a high calorific value. For future works, it is suggested to perform analyses of the PDMS biodegradability, as it is a polymer with a lot of potential.

## Acknowledgment

Ana C. Gomes acknowledge the scholarship granted by FCT. This work was supported in part by the projects NORTE-01-0145-FEDER-028178, NORTE-01-0145-FEDER-029394 and NORTE-01-0145-FEDER-030171 funded by NORTE 2020 Portugal Regional Operational Program under PORTUGAL 2020 Partnership Agreement through the European Regional Development Fund and the Fundação para a Ciência

e Tecnologia (FCT). The authors also acknowledge the partial financial support by the projects UIDB/EEA/04436/2020 and UIDB/EMS/04077/2020 and UIDB/00319/2020 from FCT.

## References

- [1] Mata A, Fleischman AJ, Roy S. Characterization of Polydimethylsiloxane (PDMS) Properties for Biomedical Micro/Nanosystems. *Biomed Microdevices*. 2005;7:281-293.
- [2] Victor A, Ribeiro J, F. Araújo F. Study of PDMS characterization and its applications in biomedicine: A review. *J Mech Eng Biomech*. 2019;4:1-9.
- [3] Seethapathy S, Górecki T. Applications of polydimethylsiloxane in analytical chemistry: A review. *Anal Chim Acta* [Internet]. 2012;750:48–62. Available from: <http://dx.doi.org/10.1016/j.aca.2012.05.004>.
- [4] Anwer AAW, Naguib HE. Determining thermo-mechanical properties of polydimethylsiloxanes from their strain-induced spectral fingerprints. *J Polym Sci Part B Polym Phys*. 2019;57:359-367.



# Mechanical properties of pure PDMS and the combination of textile fabric with PDMS

Flaminio C. P. Sales<sup>1</sup>, Andrews V. A. Souza<sup>2,3</sup>, João E. Ribeiro<sup>2</sup>, Rui A. Lima<sup>3</sup>

<sup>1</sup> *Federal University of Technology – Paraná, Brazil | Polytechnic Institute of Bragança (IPB), Portugal*

<sup>2</sup> *Polytechnic Institute of Bragança (IPB), Bragança, Portugal*

<sup>3</sup> *Mechanical Engineering Department, University of Minho, Campus de Azurém, Guimarães, Portugal*

\* [flaminio@alunos.utfpr.edu.br](mailto:flaminio@alunos.utfpr.edu.br)

## Introduction

The COVID-19 pandemic created an emergency state that changed daily habits all around the world, imposing restrictive measures as face masks used to curb the virus spread. However, usually masks hide the user's face and can affect human interaction and expressions. Moreover, there is an increasing necessity for more comfortable and breathable alternatives [1, 2]. Thus, PDMS, a transparent elastomer widely used for biomedical applications, is a promising material to achieve these requirements. Also, textile fabrics are already commonly used to cloth masks manufacture because of their availability and cost.

Understand the mechanical properties of these materials and its combination is the main purpose of this research as an essential step to develop trustable and efficient products towards supplying this emergent global need [3, 4].

## Materials and methods

To study how the temperature affects the PDMS properties, mechanical tests were conducted using materials cured at 25, 100, 120 and 140°C. The pure elastomer ("TR" sample group) was inspected in tensile, using die-C samples (D412-16 standard) and in hardness shore A according to ASTM D2240-15.

Besides that, PDMS + fabric was inspected under own methodology to discover if these materials have good adhesion and how the superposition width can affect the materials' characteristics. These specimens ("TX" samples) had 3 regions: one with pure PDMS, one only made of woven pressed between two metallic parts and a third one with a combination of both materials.

## Results and discussion

The results showed an increase on the Young's Modulus in a range of 0.927-2.196MPa as the temperature increases (as shown in Figure 1a). Also, the hardness, represented in Figure 1b, increases linearly with the temperature, approaching the first-degree curve by a coefficient of determination ( $R^2$ ) of 0.988. These hardness values are comparable with the literature [5].

Due to the longer time with liquid PDMS inside the molds, "TX" samples made at 25°C absorbed more elastomer at the combination region, compromising air permeability and breathability (Figure 2b).

All "TX" specimens broke at PDMS region, showing that textile fabric can be used to enhance the mask's tensile resistance. Finally, the highest values of maximum stress were achieved for smaller overlaps, varying approximately 12% when the superposition width reduces from 10 to 5mm. As for curing temperatures, greater resistance was obtained at 120°C; with values 61% higher than those showed for curing at 25°C.

**Figure 1**

a) Stress versus Strain curves for pure PDMS samples and Young's Modulus, showing an increase on the slope of the linear region (considered until 5% of deformation) as the temperature increases  
 b) Hardness Shore A values increasing approximately linearly as the temperature increases.

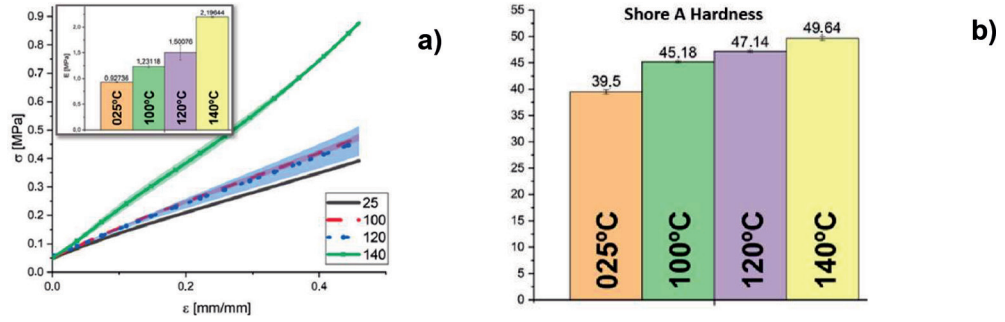

**Figure 2**

PDMS and textile samples (TX) a) Maximum stress reached, increasing until curing temperatures of 120°C and showing higher values for smaller overlaps;  
 b) PDMS absorption by textile: Regions painted in black did not present any absorption, white regions showed high elastomer infiltration, compromising materials permeability and breathability.

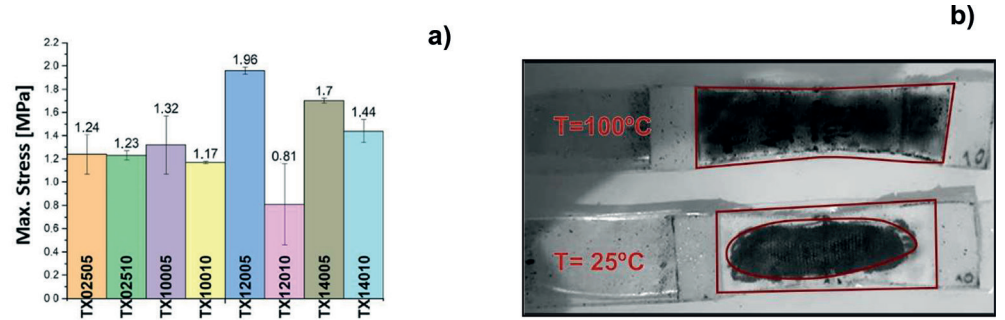

Conclusions

As all samples with textile material broke at the PDMS region, was proved that the fabric used has higher tensile strength than the elastomer. So, this material can be used as a reinforcement in a future mask with a recommended 5mm superposition.

The reduced process time is attractive when high curing temperature is used. However, due to the change in the Elastic Modulus, in a range of 0.927-2.196MPa, and in the hardness, from 39 HA at room temperature to almost 50HA at 140°C, is highly recommended study if this change can affect masks comfort. Lastly, the use of temperatures above 100°C proved to be a good alternative to avoid elastomer infiltration during the molding process.

Acknowledgment

Flaminio Sales and Andrews Souza acknowledge the scholarship granted by FCT. The authors acknowledge the FCT (Fundação para a Ciência e Tecnologia) scholarship and financial support by the projects UIDB/EEA/04436/2020, UIDB/EMS/04077/2020 and UIDB/00319/2020 also granted by FCT. This work was supported in part by the projects NORTE-01-0145-FEDER-028178, NORTE-01-0145-FEDER-029394 and

NORTE-01-0145-FEDER-030171 funded by NORTE 2020 Portugal Regional Operational Program under PORTUGAL 2020 Partnership Agreement through the European Regional Development Fund and the FCT. The authors also acknowledge the Polytechnic Institute of Bragança for the laboratories using.

## References

- [1] Cordis-EU, “trending science: Are masks the new face of our society? Science and the changing landscape of human expression,” Community Research and Development Information Service- European Commission, 2020.
- [2] K. Zhang, T. N. Vilches, M. Tariq, A. P. Galvani, and S. M. Moghadas, “The impact of mask-wearing and shelter-in-place on COVID-19 outbreaks in the United States,” *Int. J. Infect. Dis.*, Oct. 2020.
- [3] V. Kalyaev, A. I. Salimon, and A. M. Korsunsky, “Fast mass-production of medical safety shields under COVID-19 quarantine.” *Int. J. Environ. Res. Public Health*, vol. 17, no. 10, 2020.
- [4] A. Konda, A. Prakash, G. A. Moss, M. Schmoltdt, G. D. Grant, and S. Guha, “Aerosol Filtration Efficiency of Common Fabrics Used in Respiratory Cloth Masks,” *ACS Nano*, vol. 14, no. 5, pp. 6339-6347, May 2020.
- [5] I. D. Johnston, D. K. McCluskey, C. K. L. Tan, and M. C. Tracey, “Mechanical characterization of bulk Sylgard 184 for microfluidics and microengineering,” *J. Micromechanics Microengineering*, vol. 24, no. 3, 2014.

## How can we make breathable PDMS?

Ana Rita Cacho<sup>1</sup>, Renata Maia<sup>2\*</sup>, Rosa Monteiro<sup>1\*\*\*</sup>, Raquel Rodrigues<sup>3</sup>, Graça Minas<sup>3</sup>, João Miranda<sup>4</sup>, Diana Pinho<sup>3,5</sup>, Rui A. Lima<sup>4,5</sup>

<sup>1</sup> *University of Minho, Campus de Azurém, Guimarães, Portugal*

<sup>2</sup> *Faculty of Engineering of the University of Porto, Rua Dr. Roberto Frias, Porto, Portugal*

<sup>3</sup> *Center for MicroElectromechanical Systems (CMEMS-UMinho), University of Minho, Campus de Azurém, Guimarães, Portugal*

<sup>4</sup> *CEFT, Faculty of Engineering of the University of Porto, Rua Dr. Roberto Frias, Porto, Portugal*

<sup>5</sup> *Mechanical Engineering and Resource Sustainability Center (MEtRICs), University of Minho, Campus de Azurém, Guimarães, Portugal*

\* rita.cacho@inl.int; \*\*renatapfmaia@gmail.com, \*\*\*rosamonteiro129@live.com.pt

## Introduction

Coronavirus is a severe pathogen that primarily targets the human respiratory system, being mostly transmitted via person-to-person. This transmission occurs mainly via direct contact or through droplets spread by speaking, coughing or sneezing from an infected individual [1]. Face masks are a type of personal protective equipment (PPE) which plays a crucial role in reducing virus transmission, by preventing the spread of respiratory infections when social distancing is not possible [2]. In general, a traditional face mask covers a major part of the human face, which can crucially affect social interaction, once our faces provide the key information of personal identity [3]. In this regard, the main goal of the i9MASKS project is to improve our lives and our communication with others, by creating a transparent and breathable face mask. To this end, this project was based on the use of PDMS for the manufacture of masks, a transparent and biocompatible material, ideal for being in contact with the skin without causing allergies, providing the necessary transparency for people to recognize each other and to communicate. This approach is extremely favourable for the contact between healthcare professionals, between the healthcare professional and patients, between people, and special favourable for the voiceless and deaf people who resort to lip reading. The objective of our work was to create pores in the PDMS mask that allow air to pass through, so that the mask is breathable but preventing the virus.

## Materials and methods

A strategy to create microporous was tried with 5 reagents such as diluent, PDMS solvent, white petroleum (WP), petroleum ether (PE), trichloromethane. Thus, each reagent was added within the PDMS oligomer in a mass ratio of 10 (PDMS-oligomer) per 3 (reagent). The mixture was blended using a vortex for 5 minutes, water was added in a ratio of 10:3:1 and then the mixtures were mixed again. After that the mixture was put into the oven for 10 minutes at 80°C degrees. Then, PDMS crosslinker was added, vortex was used again. Finally, the mixture was degassed into a vacuum desiccator for 15 minutes. Two samples of each reagent were obtained, and one stayed at room temperature for long curing and the other went to the oven for 20 minutes at 120 °C.

An alternative with solid porogen was tested following a protocol given by Sylvie et al. Thus, sugar particles are added within the PDMS (10:1) in mass ratios of 4 and 6 (sugar) per 1 (PDMS). The mixture was cured in an oven for 2h at 80°C and then soaked in a water bath to dissolve the sugar and thereby obtain the microporous PDMS foam. At the end, the PDMS foam was placed again in the oven for 1h 30 min at 75°C to remove the excess of water. A microporous PDMS was fabricated using an emulsion of PDMS and water. For that, an SDS solution with a mass ratio of SDS to DI water of 1:100 was prepared and added to PDMS pre-polymer with a mass ratio of 1, 5, 8 and 10 %. The water can be added step by step to facilitate the blending. After that, some DI water was added to a high temperature durable container and then the

petri dish with the water-in-PDMS emulsion was put inside on the water. Then the container was covered with the lid and further put into the oven for about 2 hours at 80°C. When the PDMS was partly cured, the petri dish was removed and finish curing for about 1 more hour.

In order to determine the breathability of the samples produced, tests were carried out to determine air permeability with the FX 3300 Air Permeability tester III from TEXTEST INSTRUMENTS. The tests were carried out according to the Portuguese standard NP ISO 9237: 1995. The sample area was 20 cm<sup>2</sup> and the pressure used was 200 Pa, since the PDMS fits the non-woven type.

## Results and discussion

For most of the samples, the best results were obtained when left at RT (Figure 1). By comparing all methods, it is possible to observe that the sample with the smallest pores is the solvent sample, while the PE sample has some pores and the trichloromethane sample has no pores or it is not visible with this device. For the PE sample at RT, the permeability tests as shown a permeability of 8.69 m<sup>2</sup>/s while the Trichloromethane RT and Solvent RT samples had no permeability air ( $R = 0$  m<sup>2</sup>/s).

**Figure 1**

Samples cured at RT  
A: Sample Solvent B:  
Sample WP C: Image  
of PE sample observed  
at optical microscopic  
with a 400x. D: Sample  
PE E: Sample Trichlo-  
romethane F: Image  
of trichloromethane  
sample observed at  
optical microscopic with  
a 400x.

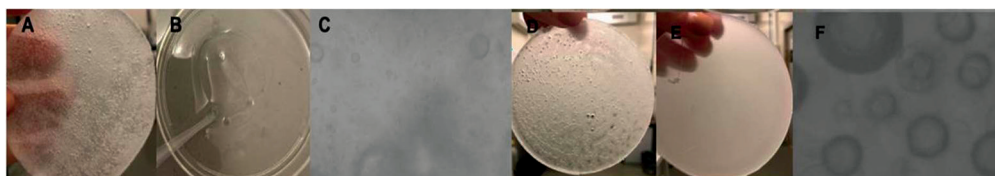

Instead of using a soluble porogen, this experiment was performed using sugar, which is consider a solid porogen, and the results of permeability tests as shown a permeability of 23.2 m<sup>2</sup>/s. Other procedures with SDS was tested. Once DI water is considering a porogen, a solution with 1% of SDS in DI water was prepared and added to PDMS with a mass percentage of 1,5,8 and 10%. Samples were analyzed by optical microscope. Figure 2 shows the results obtained with the increasing amount of SDS in DI water solution. As it possible to observe, by increasing the amount of SDS in DI water solution it increases the porosity but decreases the transparency of the sample. Also, although the porosity was increased, there is no connection between the pores, which was confirmed by the permeability tests that had null results for the SDS samples.

**Figure 2**

Samples with and  
increase amount of SDS  
in Diwater solution.

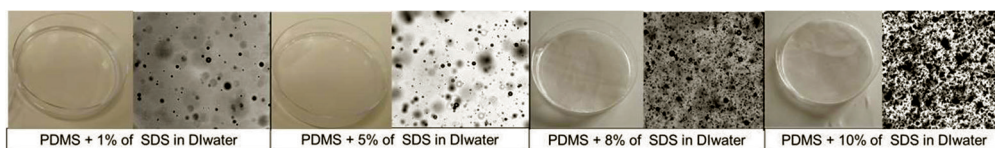

## Conclusions

The minimum air flow for samples to be considered breathable is 69 m<sup>2</sup>/s, thus, no sample proved to be suitable for use in masks as they are not breathable. However, the samples showed a high level of pores when analyzed under an optical microscope, that way, it is important to study a way to make these pores interconnected, increasing the breathability of the samples to be used in masks. As future work, we suggest studying the combination of sugar or other solid porogens with Petroleum ether, that is, the reagents that revealed positive results of air permeability.

## Acknowledgment

Renata Maia, Ana Rita Cacho, Rosa Monteiro acknowledge the scholarship granted by FCT. This work was supported in part by the projects NORTE-01-0145-FEDER-028178, NORTE-01-0145-FEDER-029394 and NORTE-01-0145-FEDER-030171 funded by NORTE 2020 Portugal Regional Operational Program under PORTUGAL 2020 Partnership Agreement through the European Regional Development Fund and FCT. The authors also acknowledge the partial financial support by the projects UIDB/EEA/04436/2020 and UIDB/EMS/04077/2020 from FCT.

## References

- [1] Howard J, Huang A, Li Z, Tufekci Z, Ždímal V, Westhuizen H-M, et al. Face Masks Against COVID-19: An Evidence Review PNAS, 2020.
- [2] Rothan HA, Byrareddy SN. The epidemiology and pathogenesis of coronavirus disease (COVID-19) outbreak. *Journal of Autoimmunity*. 109:102433, 2020.
- [3] Javid B, Weekes MP, Matheson NJ. COVID-19: should the public wear face masks? *BMJ*, 369:m1442, 2020.



# UV-C sterilization of PDMS

Inês Miranda<sup>1</sup>, Inês Castro<sup>1</sup>, V. C. Pinto<sup>2</sup>, P.J. Sousa<sup>2</sup>, G. Minas<sup>2</sup>

<sup>1</sup> *University of Minho, Campus de Azurém, 4800-058 Guimarães, Portugal*

<sup>2</sup> *Center for MicroElectromechanical Systems (CEMS-UMinho), University of Minho, Campus de Azurém, 4800-058 Guimarães, Portugal*

\* a80803@alunos.uminho.pt, \*a81699@alunos.uminho.pt

## Introduction

Summer School, i9MASKS, aims to develop a transparent face mask, using PDMS as the main material. One of the requirements of a reusable mask is that it should be sterilizable. The purpose of this project is to fulfil this requirement.

UV-C is a spectral range (between 200 and 280 nm) widely used for sterilization. Studies have shown that UV-C light is capable of inactivating SARS-CoV-2 virus [1]. Based on this, it is needed to verify that PDMS is not degraded after being exposed to UV-C light.

Commercial sterilizers commonly use UV-C LED's at 280 nm. Observing the absorption spectrum of PDMS, it is possible to conclude that this material practically does not absorb radiation above 250 nm [2]. Because of this, it is expected that a 280 nm wavelength light will not degrade PDMS.

## Materials and methods

This work was divided in two parts. The purpose of the first step was to verify if UV-C light does not degrade PDMS. In order to accomplish this, there were performed wettability, transparency and mechanical assays, before and after UV-C sterilization. The sterilization procedure was performed using a commercial sterilizer that emits a light at 280 nm.

A variety of samples were tested: PDMS with ratios of 10:1 and 25:1 and QSil (which is also an elastomer) with the conventional ratio, 10:1. Samples of 2 and 3 mm thick were made and cured with a temperature of 70°C.

The second step consisted in verifying if the commercial sterilizer was working as supposed. PDMS samples were placed in a culture of microalgae. These microorganisms have the property of fluorescence when alive, so it is expected a decrease of the fluorescence after sterilization [3]. Two types of sterilization were performed: one using the commercial sterilizer and another placing the contaminated samples in boiled water (~90°C).

## Results and discussion

After sterilization, no significant differences were observed, neither in wettability nor in transparency assays, as it can be seen in Table 1 and Figure 1. Mechanical assays could not be performed due to technical issues.

**Table 1**  
Goniometry results.  
Contact angle measurement.

Wettability	Contact Angle (°)	
	Before Sterilization	After Sterilization
PDMS, 10:1, 2mm	121.7 ± 1.7	115.5 ± 2.0
PDMS, 10:1, 3mm	118.3 ± 4.9	118.1 ± 0.6
PDMS, 25:1, 2mm	125.1 ± 6.7	129.4 ± 1.4
PDMS, 25:1, 3mm	128.9 ± 3.2	124.7 ± 2.0
QSil, 10:1, 2mm	113.4 ± 2.7	121.6 ± 3.5
QSil, 10:1, 3mm	117.8 ± 3.6	118.7 ± 3.8

**Figure 1**  
Transmittance curve for PDMS, 10:1, 2mm samples before and after UV-C sterilization.

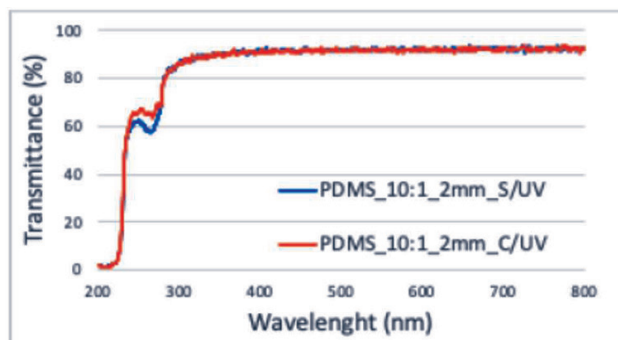

In Figure 2, it is observed a native PDMS sample and its respective optical microscopy image. It is noticeable that the PDMS sample is not fully cleaned. It presents dust and stains due to the surrounding environment. Figure 3 represents a PDMS sample contaminated with microalgae. In the microscopic image, it is observed those microorganisms. PDMS after sterilized with boiled water can be observed in Figure 4.

The microalgae culture used were already dead before UV-C exposure, so it was not possible to conclude about the effectiveness of the sterilizer equipment. Moreover, full cleaning of PDMS was achieved after 2 min in boiled water, however the PDMS samples showed some turbidity, as shown in Figure 4.

**Figure 2**  
Native PDMS, 10:1.  
a) visual appearance;  
b) optical microscopy.

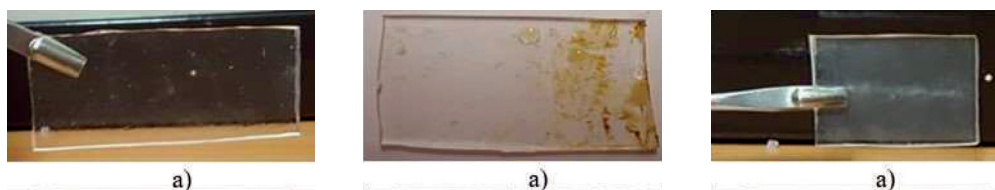

**Figure 3**  
PDMS contaminated with microalgae, 10:1.  
a) visual appearance;  
b) optical microscopy.

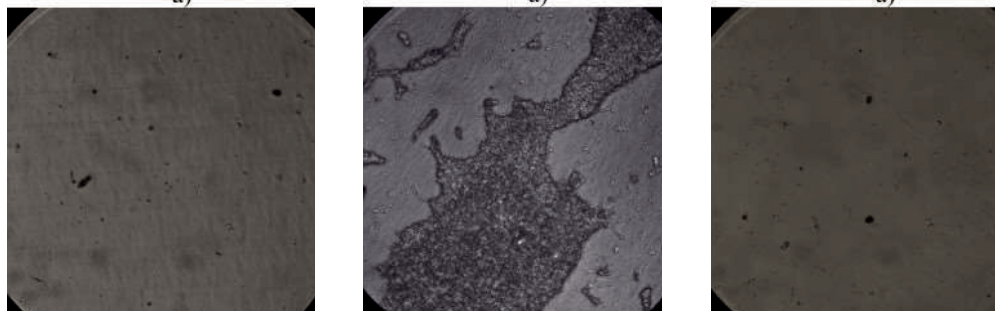

**Figure 4**  
Boiled PDMS, 10:1.  
a) visual appearance  
b) optical microscopy.

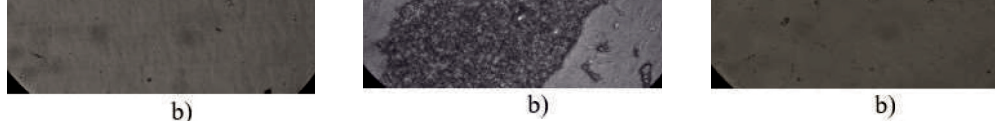

## Conclusions

In conclusion, it was not possible to ensure that UV-C light does not degrade PDMS because mechanical assays could not be performed. However, taking in consideration that PDMS does not absorb at 280 nm and based on the wettability and transparency assays' results, it is possible to assume that PDMS is not affected by this wavelength.

It is important to notice that UV sterilization only inactivates the microorganism, it does not clean the PDMS, which means that dust and stain will remain after the sterilization procedure.

Conclusions about the effectiveness of the commercial sterilizer equipment could not be taken, because microalgae were dead before the sterilization. However, if the equipment specifications are correct and the UV-C LED has a wavelength of 280 nm, it will work as supposed, as can be proved by the literature.

## Acknowledgment

Inês Miranda and Inês Castro acknowledge the scholarships granted by FCT. The authors also acknowledge the partial financial support by the projects NORTE-01-0145-FEDER-029394, NORTE-01-0145-FEDER-030171 and NORTE-01-0145-FEDER-028178, supported by Programa Operacional Regional do Norte - Norte Portugal Regional Operational Programme (NORTE 2020), under the PORTUGAL 2020 Partnership Agreement, through the European Regional Development Fund (FEDER) and by Fundação para a Ciência e Tecnologia (FCT), IP, projects PTDC/EMD-EMD/29394/2017, PTDC/EME-SIS/30171/2017. The authors also acknowledge the partial financial support by FCT national funds, under the national support to R&D units grant, through the reference project UIDB/04436/2020, UIDP/04436/2020, UIDB/EMS/04077/2020 and UIDB/00319/2020.

## References

- [1] Matthieu Verstraete, Joel Thome. (2020). UV-C LED's at the time of COVID-19, 2020 Application and Technical Report. PISÉO, Centre d'innovation optique et photonique, Available from: [https://s3.i-micronews.com/uploads/2020/10/PR20183-UV-C-LEDS-at-the-time-of-COVID-19\\_sample.pdf](https://s3.i-micronews.com/uploads/2020/10/PR20183-UV-C-LEDS-at-the-time-of-COVID-19_sample.pdf), accessed on 24 October 2020.
- [2] Patterning Flood Illumination with Microlens Arrays – Scientific Figure on ResearchGate. Available from: [https://www.researchgate.net/figure/Absorption-spectrum-of-PDMS-This-spectrum-shows-that-PDMS-as-a-membrane-1-cm-thick\\_fig14\\_11362545](https://www.researchgate.net/figure/Absorption-spectrum-of-PDMS-This-spectrum-shows-that-PDMS-as-a-membrane-1-cm-thick_fig14_11362545), accessed on 24 October 2020.
- [3] Grigoryeva, N., & Chistyakova, L. (2018). Fluorescence microscopic spectroscopy for investigation and monitoring of biological diversity and physiological state of cyanobacterial cultures. In *Cyanobacteria* (pp. 11-43). IntechOpen.

# Study of the development of PDMS microchannels for incorporation in masks

Renata de O. Diehl<sup>1\*</sup>, Rui A. Lima<sup>2,3</sup>, Susana O. Catarino<sup>1</sup>

<sup>1</sup> *Center for MicroElectromechanical Systems (CMEMS-UMinho), University of Minho, Campus de Azurém, Guimarães, Portugal*

<sup>2</sup> *Mechanical Engineering and Resource Sustainability Center (MEtRICS), University of Minho, Campus de Azurém, Guimarães, Portugal*

<sup>3</sup> *CEFT, Faculty of Engineering of the University of Porto, Rua Dr. Roberto Frias, Porto, Portugal*

\* *denisemotacarvalho@gmail.com*

## Introduction

The SARS-CoV-2 coronavirus, that causes the COVID-19 disease, was first detected, in December 2019, in Wuhan, China, according to data from the World Health Organization (WHO).

Transmission occurs mainly from person to person through respiratory droplets, when the individual coughs, sneezes or speaks close to other people. Contaminated surfaces or objects can also be sources of transmission [1]. The main form of control in the fight against the new virus has been the use of Personal Protection Equipment and social distance. Therefore, the general population has been oriented to use masks as a mechanical barrier to prevent droplet dispersion [2, 3]. One of the problems encountered in the constant use of masks is related to the misting and condensation of water droplets expelled during breathing, requiring a study of alternatives that would solve such adversity. When addressing mask alternatives, another criterion is transparency, as the material should be colourless to enable face recognition. In this context, this work studied the incorporation of polydimethylsiloxane (PDMS) microchannels [4] into polymeric masks, with the purpose of creating air circulation regions, overcoming the masks current limitations.

## Materials and methods

The methodology addressed in this work consisted on the development of two-dimensional and three-dimensional spring-shaped microchannels in PDMS, with polymeric moulds manufactured through 3D printing.

The print models of the springs were designed in the CAD software Autodesk Fusion 360, with external diameters of 25 mm and channel thicknesses of 0.5 mm, 1 mm and 2 mm. Then, the CAD models were exported to the Ultimaker Cura 4.7 software, where the print settings (speed, support, as well as techniques and extrusion settings) were defined. Based on the defined print settings, the moulds were printed on PolySmooth polymeric material, and the printing was followed by a polishing process with isopropyl alcohol during 10 min. The polished springs were inserted in the PDMS matrix inside a Petri dish (with 10:1 ratio and curing during 6h at 40°C).

Finally, the matrices were immersed in isopropyl alcohol at 60°C, in order to promote the degradation of the PolySmooth polymer, until the complete formation of the channel. Figure 1 summarizes the processes of CAD design, moulds printing and PDMS replication.

## Results and discussion

As observed in Figure 2, the removal of the moulds was complete for planar structures (left image), whereas in three-dimensional structures (centre and right images), complete removal did not occur, as PolySmooth only interacted with the solvent at

the mould ends (as can be observed in the detail presented in the right image), increasing the polymer decomposition time. No interactions were detected between the mould and the matrix polymers.

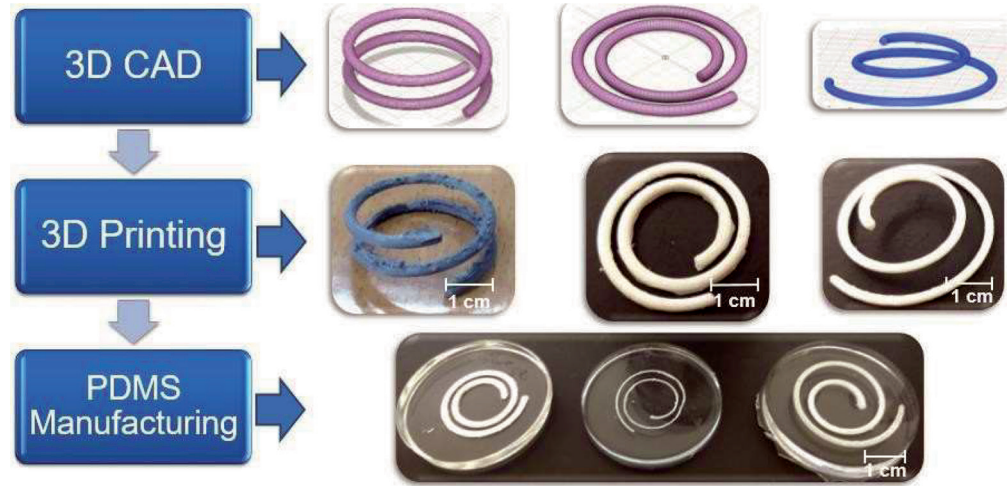

**Figure 1**  
Scheme of the 3D CAD design, mould printing and PDMS manufacturing processes.

The results of this research were quite satisfactory, since an alternative was found to solve the problem of breathability and condensation in PDMS masks, using 3D printed channels. These microstructures can be incorporated during manufacture and are easily removable by immersion in isopropyl alcohol, which does not cause damage when interacting with the PDMS.



**Figura 2**  
PolySmooth removal process by immersion in isopropyl alcohol and formation of PDMS fluidic channels.

## Conclusions

The results of the carried out experimental work were quite satisfactory, since an alternative was found capable of solving the problem of breathability and condensation in masks produced in PDMS, using moulds of channels printed on a 3D printer. These structures and microstructures can be incorporated during manufacture, for replication of their geometry in the PDMS, being easily removable by immersion in isopropyl alcohol, which does not cause damage or interact with the PDMS of the masks.

The presented results are a starting point for future work in the field of breathability of polymeric masks and reduction of fogging. The present work demonstrated the possibility of simple manufacturing, only through 3D printing and degradation, of

planar and three-dimensional structures, with easy integration in PDMS matrices. This work is not limiting regarding the dimensions that may be reached, with the potential for its reduction down to a sub-millimetric scale, whether for the incorporation of microchannels or micro-holes in PDMS masks. Thus, it is expected that this work will contribute to solve the current problems of condensation and breathability of transparent polymeric masks.

## Acknowledgment

Renata de O. Diehl acknowledges the scholarship granted by FCT. This work was supported by the Projects NORTE-01-0145-FEDER-028178, NORTE-01-0145-FEDER-029394 and NORTE-01-0145-FEDER-030171 funded by NORTE 2020 Portugal Regional Operational Program under PORTUGAL 2020 Partnership Agreement through the European Regional Development Fund and the Fundação para a Ciência e Tecnologia (FCT). The authors also acknowledge the partial financial support by the projects UIDB/EEA/04436/2020, UIDB/EMS/04077/2020 and UIDB/00319/2020 from FCT.

## References

- [1] WHO Director-General's opening remarks at the media briefing on COVID-19. (11 Mar 2020). Available at: <https://www.who.int/dg/speeches/detail/who-director-general-s-opening-remarks-at-the-media-briefing-on-covid-19-11-march-2020>.
- [2] Van Doremalen N. Aerosol and Surface Stability of SARS-CoV-2 as Compared with SARS-CoV-1" *N Engl J Med.* 2020; V. 382: 1564-7. DOI: <http://dx.doi.org/10.1056/NEJMc2004973>
- [3] World Health Organization – WHO Advice on the use of masks in the context of COVID-19: interim guidance, 5 June 2020, WHO/2019-nCov/IPC\_Masks/2020.4
- [4] Moreira N. R. P. "Estudo de várias propriedades mecânicas do polidimetilsiloxano (PDMS) usado em dispositivos biomédicos". Master Dissertation, October 2013. Available at: <https://bibliotecadigital.ipb.pt/bitstream/10198/9275/1/N%c3%baria%20Moreira.pdf>



# Numerical simulation: study on the path of expelled and expired water vapor particles

Inês Teixeira<sup>1</sup>, Violeta Carvalho<sup>2</sup>, Senhorinha Teixeira<sup>3</sup>, Nélson Rodrigues<sup>1,2,3</sup>

<sup>1</sup> *Mechanical Engineering Department, University of Minho, Campus de Azurém, Guimarães, Portugal*

<sup>2</sup> *Mechanical Engineering and Resource Sustainability Center (MEtRICs), University of Minho, Campus de Azurém, Guimarães, Portugal*

<sup>3</sup> *ALGORITMI, University of Minho, Campus de Azurém, Guimarães, Portugal*

\* a80255@alunos.uminho.pt

## Introduction

Numerical simulation is a tool that provides a prediction of a physical phenomenon, reducing the need of physical tests. To predict and visualize the spread of the COVID-19 virus from the nose and mouth, simulations of expelled and expired water particles were performed. The study was performed in Ansys Fluent® software in a 2D environment. The developed models need physical variables that were previously researched. To have confidence in the results, the convergence of the models is always verified, and only later the optimization of the models can be performed. Some conditions of the flow are complex and need to be defined by a User Defined Function, such as the velocity of the respiration profile, combined with sneeze or cough. Through the description of the DPM iteration intervals, which allows control over the frequency at which the particles are tracked, it is possible to have a report of the particles that are injected and how they propagate in space, that is, if they evaporate, stay trapped or escape outside the analysis domain (1).

## Materials and methods

Initially, a stationary analysis of particles expired by the nose and expelled by the mouth was performed, modeling a simple nose and mouth geometry. At a later stage, some parameters were corrected, and a transient analysis was performed, as exposed in table 1.

Variables	Value						Units
Air flow velocity	1,6755[2]						m/s
Mass flow	0,01 [2]						Kg/s
Particle diameter	Min.	1e-6	Aver.	5e-5	Max.	0,001 [1]	m
Particle velocity X	1[2]						m/s
Particle velocity Y	-0,6755[2]						m/s

**Table 1**  
Variables applied to particles in numerical simulations.

The respiratory cycle was later defined using the conditions expressed in table 2. In an intermediate phase, the study of the particles' trajectory, which are exhaled by the nose during breathing, was carried out with the implementation of the sinusoidal equation 1. At a later stage, UDFs were created to implement the respiratory reactions. UDF 1 defines the occurrence of a sneeze, using equation 2, while UDF 2 defines the occurrence of a cough period, using equation 3.

	Breathing cycle		Respiratory Reaction	Breathing cycle
UDF 1	$v(t) = 0,85\sin(\frac{\pi t}{1,5})$ (1)	Sneeze	$v(t) = 15\exp(-22t)$ (2)	$v(t) = 0,85\sin(\frac{\pi t}{1,5})$ (1)
UDF 2	$v(t) = 0,85\sin(\frac{\pi t}{1,5})$ (1)	Cough	$v(t) = 11\exp(-32t) + 0.27$ (3)	$v(t) = 0,85\sin(\frac{\pi t}{1,5})$ (1)
Time(s)	[0,2,0[		[2,0,2,2[	[2,2,10]

**Table 2**  
Sequence followed by UDFs.

## Results and discussion

The respiratory cycle, simplified as a sinusoidal (equation 1), is presented in Figure 1 a). The next study addresses the particle dispersion when a sneeze and later a cough occur.

Since the velocity and input angle vary, mouth and nose were studied separately, with the latter having greater propagation and causing greater concern. The results were then focused on the particles that exited the mouth during a sneeze, Figure 1 b), and cough Figure 1 c).

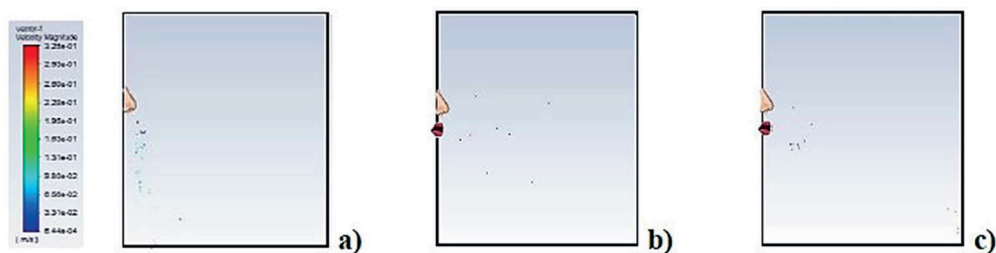

**Figure 1**  
Study of the path of particles along a respiratory cycle a), during a sneeze b) and during a cough c).

The particle expelled from the mouth have a wider range, which is related to the horizontality of the flow and particles exiting the mouth.

The propagation occurs along the flow, which will depend on the air flow velocity and also of velocity of the particles.

## Conclusions

In the DPM report there are four possible situations that happen: escaped, trapped, evaporated and lost particles (not monitored). From the DPM results obtained, the particles expired during a cough period tend to escape or become trapped, while particles expired during a sneeze tend to evaporate.

Water vapor particle monitoring served to study the behaviour of COVID-19 and predict the risk of contagion.

## Acknowledgment

Inês Teixeira acknowledges the scholarship granted by FCT. This work was supported in part by the projects NORTE-01-0145-FEDER-028178, NORTE-01-0145-FEDER-029394 and NORTE-01-0145-FEDER-030171 funded by NORTE 2020 Portugal Regional Operational Program under PORTUGAL 2020 Partnership Agreement through the European Regional Development Fund and the Fundação para a Ciência e Tecnologia (FCT). The authors also acknowledge the partial financial support by

the projects UIDB/EEA/04436/2020, UIDB/EMS/04077/2020 and UIDB/00319/2020 from FCT.

## References

- [1] M. A. dos A. Corvo, C. A. Eckley, L. V. Rizzo, L. R. Sardinha, T. N. Rodriguez, and I. Bussoloti Filho, "Salivary transforming growth factor alpha in patients with Sjögren's syndrome and reflux laryngitis," *Braz. J. Otorhinolaryngol.*, vol. 80, no. 6, pp. 462–469, 2014, doi: 10.1016/j.bjorl.2014.08.006.
- [2] J. W. Tang et al., "Airflow Dynamics of Human Jets: Sneezing and Breathing - Potential Sources of Infectious Aerosols," *PLoS One*, vol. 8, no. 4, pp. 1-7, 2013, doi: 10.1371/journal.pone.0059970.
- [3] C. N. Ngonghala, E. Iboi, and A. B. Gumel, "Could masks curtail the post-lockdown resurgence of COVID-19 in the US?," *Math. Biosci.*, 2020, doi: 10.1016/j.mbs.2020.108452.

# Numerical simulation – A study of porosity and space

Bernardo Faria<sup>1</sup>, Cláudia Oliveira<sup>1</sup>, Violeta Carvalho<sup>2</sup>, Senhorinha Teixeira<sup>3</sup>,  
Nélson Rodrigues<sup>2,3</sup>

<sup>1</sup> *University of Minho, Braga/Guimarães, Portugal*

<sup>2</sup> *Mechanical Engineering and Resource Sustainability Center (MEtRICs), University of Minho, Campus de Azurém, Guimarães, Portugal*

<sup>3</sup> *ALGORITMI, University of Minho, Campus de Azurém, Guimarães, Portugal*

## Introduction

Numerical simulation is a viable way of predicting the behaviour of a physical system, i.e. its inherent properties: material and spatial. Therefore, this study consists of an attempt of combining two different studies. Being the first one a study of porosity and the second one a spatial study. In the study of porosity, it is assumed a two-dimensional physical model which consists of a simplified version of a three-dimensional physical model of a fluidic flow with transport of species through a cross-section of a pipe with a wall dotted of porosity. Therefore, a study of the effect of pressure drop of that same wall on that same flow. On the other hand, the spatial study involves an exhaustive simplification of a three-dimensional organic and complex spatial-geometrical physical system human head + mask to a two-dimensional more friendly computational physical system (Figure 2). Finally, by combining these two studies it is possible to have a more realistic insight<sup>1</sup> of the effects of the topological and material's properties of the mask over all physical system, such as the relation between porosity of the mask and the velocity of the air flow expelled through a sneeze, and by consequence the maximum distance reachable by the air flow with its carried particles.

## Materials and methods

To proceed with this study, it was used the ANSYS® Fluent® 2020 R2 Academic software. For the sub-study of porosity, an essential and initial step was the definition and selection of the physical models: the species Transport, to connect the chosen species (water and air) and the DPM (Discrete Phase Model), to make injections of water particles. Sequentially, there are two options to define the porosity in the medium available in Ansys Fluent: Porous Zone and Porous Jump. The Porous Jump, which consists in a unidimensional simplification of Porous Zone, was the chosen model, because it's simple, and has the possibility to connect with the DPM [1]. A simplification ruled for the pressure drop related to the medium ( $\Delta p$ ) in function of the velocity normal to the porous face ( $v$ ) is used to define this model. Furthermore, it was necessary to define some porous jump parameters, as shown in Table 1.

$$\Delta p = -\left(\frac{\mu}{\alpha}v + C_2 \frac{1}{2}\rho v^2\right)\Delta m \quad (1)$$

Physical Variable	Parameter	Value
Laminar fluid viscosity	[ Pa.s]	1.72e-5
Thickness of the medium	$\Delta m$ [m]	0.002
Inertial resistance	$C_2$ [1/m]	2.215
Permeability of the medium	$\alpha$ [m <sup>2</sup> ]	4.87e-7
Fluid density	$\rho$ [kg/m <sup>3</sup> ]	997

**Table 1**  
Porous Jump parameters [2].

<sup>1</sup> Under hardware and software limitations.

In the spatial sub-study, by using Geometry Ansys Academic R2020 it was possible to simplify the three-dimensional initial complex case of Figure 1 to a two-dimensional case, with this simplification being needed due to hardware and software limitations. Consequently, it is possible to introduce the two-dimensional case of Figure 2. This two-dimensional case corresponds to the plane that contains the vertical symmetry axis of the face delimited by the mask, that is, it corresponds to the plane that divides the nose into two equal parts delimited by the height of the mask. This plane has the following dimensions: 366.07 mm X 177.97 mm.

### Results and discussion

The variations that occur due to the presence of the filter are expressed in the total flow pressure and consequently, in the total energy of the fluid, so a pressure reduction would be expected, as shown in Figure 3 – Pressure simulation in the porosity sub-study. The injection of water particles presented in Figure 4 has an unexpected behavior, since they move freely, without having any type of interaction with the filter. So, with these results it is possible to report that the Porous Jump has some limitations in terms of particle filtration, however this can be reversed by defining a connection with the DPM, which was not addressed in this study.

By combining the two sub-studies and by considering a sneeze with expulsion of air either by the nose either by the mouth with a velocity's magnitude of 3.4 m/s [3], there is the following two cases: the case where the person does not use any kind of mask (Figure 5) and the case where the person uses an approximation of a real mask with the parameters of Table 1 (Figure 6). Thereby, through the comparison of Figure 5 and Figure 6, it is possible to see that the utilization of a mask dotted of porosity can reduce the magnitudes velocity (even if it is slightly). Also, with these results, it is possible to enhance the importance of the utilization of masks during COVID-19 pandemic. [4, 5].

**Figure 1**  
3D case: human head + mask.

**Figure 2**  
2D case: human face + mask (orange region).

**Figure 3**  
Pressure simulation in the porosity sub-study.

**Figure 4**  
Direction of the water particles injection.

**Figure 5**  
Simulation of the velocity's magnitude of a sneeze simulation when the person does not use any kind of mask.

**Figure 6**  
Simulation of the velocity's magnitude of a sneeze when a person uses a mask with the parameters of Table 1.

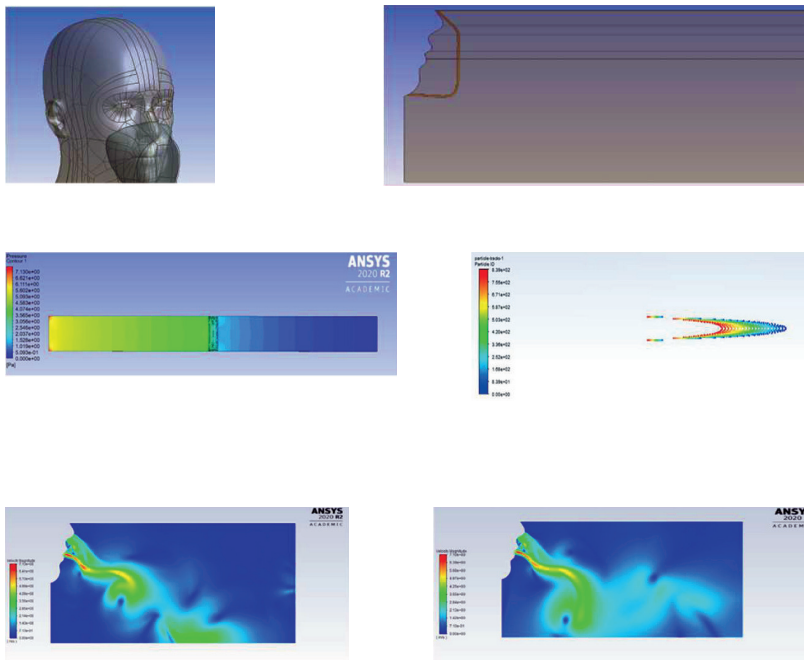

## Conclusions

The model, as defined, did not filter the water particles, so it was possible to verify the limitations of the porous model in terms of interaction with particles. Incorporating them into the study would require a more detailed knowledge of the porosity conditions and the mask properties. Despite the porous model limitation, it was possible to observe a pressure drop in the flow, so some of the considered definitions were correct. Due to the complexity of the 3D model it is not possible to simulate over it. The use of a mask with porosity can reduce the magnitude velocity of air flow of a sneeze, i.e. the maximum reachable distance, regarding the limitations of software license.

## Acknowledgment

Bernardo Faria and Cláudia Oliveira acknowledge the scholarship granted by FCT. This work was supported in part by the projects NORTE-01-0145-FEDER-028178, NORTE-01-0145-FEDER-029394 and NORTE-01-0145-FEDER-030171 funded by NORTE 2020 Portugal Regional Operational Program under PORTUGAL 2020 Partnership Agreement through the European Regional Development Fund and the Fundação para a Ciência e Tecnologia (FCT). The authors also acknowledge the partial financial support by the projects UIDB/EEA/04436/2020, UIDB/EMS/04077/2020 and UIDB/00319/2020 from FCT.

## References

- [1] Fluent, “Chapter 7.4.21. Porous Jump Boundary Conditions,” in *Fluent Users Guide*, 2020
- [2] M.I.M da Vinha, “Study of the Flow in a Modular Bag Filter”, Master’s Thesis, Universidade do Minho, Guimarães, 2019
- [3] P. Bahl, C. M. de Silva, A. A. Chughtai, C. R. MacIntyre, and C. Doolan, “An experimental framework to capture the flow dynamics of droplets expelled by a sneeze,” *Exp. Fluids*, vol. 61, no. 8, pp. 1-9, 2020.
- [4] C. C. LEUNG, K. K. CHENG, T. H. LAM, and G. B. MIGLIORI, “Mask wearing to complement social distancing and save lives during COVID-19,” *Int. J. Tuberc. Lung Dis.*, vol. 24, no. 6, pp. 556-558, 2020.
- [5] J. Howard, A. Huang, Z. Li, and A. Rimoin, “Face Masks Against COVID-19: An Evidence Review [Pre-proof]; [not peer-reviewed],” *Pnas*, no. July, 2020



# Simulation study of SARS-CoV-2 (COVID-19) by breathing, coughing and sneezing

Filipe Ferreira<sup>1\*</sup>, Susana O. Catarino<sup>1</sup>

<sup>1</sup> *Center for MicroElectromechanical Systems (CMEMS-UMinho), University of Minho, Campus de Azurém, Guimarães, Portugal*

\* [pg42063@alunos.uminho.pt](mailto:pg42063@alunos.uminho.pt)

## Introduction

According to the World Health Organization, 11 months after the first reported case, the SARS-CoV-2 (COVID-19) pandemic has infected more than 40 million people worldwide, with a mortality rate around 2,8 % [1]. The scientific community recognized transmission by airborne particles as the primary route of infection. These particles can be distinguished in droplets, with diameter  $> 10\text{-}20\ \mu\text{m}$ , composed of water, which do not travel more than 2 m. When they evaporate, these particles become aerosols, with diameter  $< 10\text{-}20\ \mu\text{m}$ , that can remain suspended in the air for more than 6 m [2].

This work aims to simulate the flow of COVID-19 infectious particles suspended in airborne particles, expelled by breathing, coughing and sneezing, with velocities of 5 m/s, 15 m/s and 40 m/s, respectively, using COMSOL Multiphysics software. Water droplets and water vapor aerosols, with  $100\ \mu\text{m}$  and  $10\ \mu\text{m}$  diameters, respectively, will be considered.

## Materials and methods

In this work, using the COMSOL laminar flow and particle tracing physics modules, 10 droplets of water ( $1000\ \text{kg/m}^3$  density and  $100\ \mu\text{m}$  diameter) and 10 water vapor aerosols ( $0.013\ \text{kg/m}^3$  density and  $10\ \mu\text{m}$  diameter) were released into the propagation domain. For the 2D domain, a 10 min analysis was performed, with particle releases at 0 s, 1 s and 2 s, while in the 3D geometry, it was performed a 20 s simulation, under the same release conditions. Concerning the mesh, for the 2D simulation a mesh with 14612 elements and an average element quality factor of 0.804 was used in COMSOL, and for the 3D simulation, due to graphical limitations, a mesh with 53099 elements and an average element quality factor of 0.617 was considered.

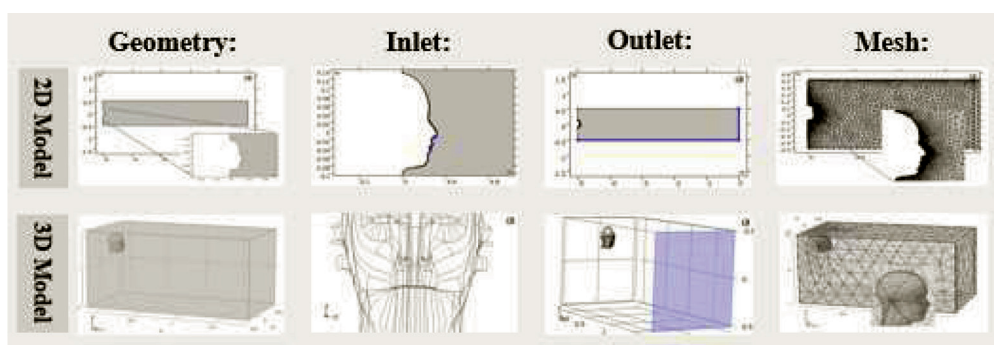

**Figure 1**  
Geometry, inlets, outlets and mesh defined for both 2D and 3D models. The inlets were chosen taking into account the mouth and nose area, while the outlets correspond to the opposite side of the release.

## Results and discussion

Firstly, the Reynolds number ( $Re$ ) for each event was calculated to demonstrate the presence of laminar flow in the air.  $Re$  values of 0.7, 2.14 and 5.7 were obtained for breathing, coughing and sneezing, respectively.

Regarding the results, it was found that, in all events, the water droplets moved only in the vertical direction, mainly due to gravity, unlike aerosols that have low density and, therefore, gravity can be neglected. It was also observed that after 10 min, when breathing, aerosols spread, horizontally, around 75 cm, about 1.5 m when coughing and about 2 m when sneezing. The maximum velocity and pressure were, respectively, 0.11 m/s and 10 mPa for breathing, 0.32 m/s and 47 mPa for coughing and 0.86 m/s and 0.13 Pa for sneezing. These results were also observed in a 3D simulation of sneezing, with maximum velocity and pressure of 0.39 m/s and 0.03 Pa, respectively.

**Figure 2**

Velocity field (m/s), pressure (Pa) and particle trajectories (at 2 s, 300 s and 600 s, respectively) obtained for both 2D and 3D models. Velocity and pressure plots have, for visualization purposes, a maximum colour scale adjustment at 0.01 m/s and 0.1 mPa, respectively. In the trajectories plots, for better visualization, the particles are magnified with a radius scale factor of 1200. The 100  $\mu\text{m}$  water droplets are represented in red, while the 10  $\mu\text{m}$  water vapor are represented in blue.

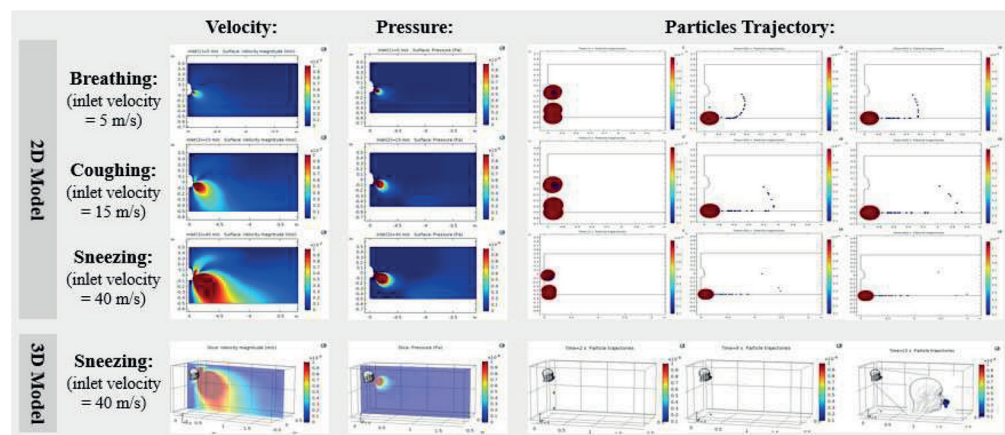

## Conclusions

In all the simulated events, the water droplets moved only in the vertical direction due to gravity, unlike aerosols that have low density and, therefore, propagate both vertically and horizontally. In sneezing, particles can travel up to 2 meters, which is the distance defined by health organizations as a minimum for social distancing. Future developments should study the feasibility of using protection masks, the effect of temperature and humidity in the particles propagation, as well as studies of propagation in closed and ventilated spaces.

## Acknowledgment

Filipe Ferreira acknowledges the scholarship granted by FCT. This work was supported in part by the projects NORTE-01-0145-FEDER-028178, NORTE-01-0145-FEDER-029394 and NORTE-01-0145-FEDER-030171 funded by NORTE 2020 Portugal Regional Operational Program under PORTUGAL 2020 Partnership Agreement through the European Regional Development Fund and the Fundação para a Ciência e Tecnologia (FCT). The authors also acknowledge the partial financial support by the projects UIDB/EEA/04436/2020 and UIDB/EMS/04077/2020 and UIDB/00319/2020 from FCT.

## References

- [1] World Health Organization. (2020). Coronavirus disease (COVID-19) pandemic.
- [2] Jayaweera, M. et al. (2020). Transmission of COVID-19 virus by droplets and aerosols: A critical review on the unresolved dichotomy. *Environmental Research*.

# I9MASKS poster, website and videos

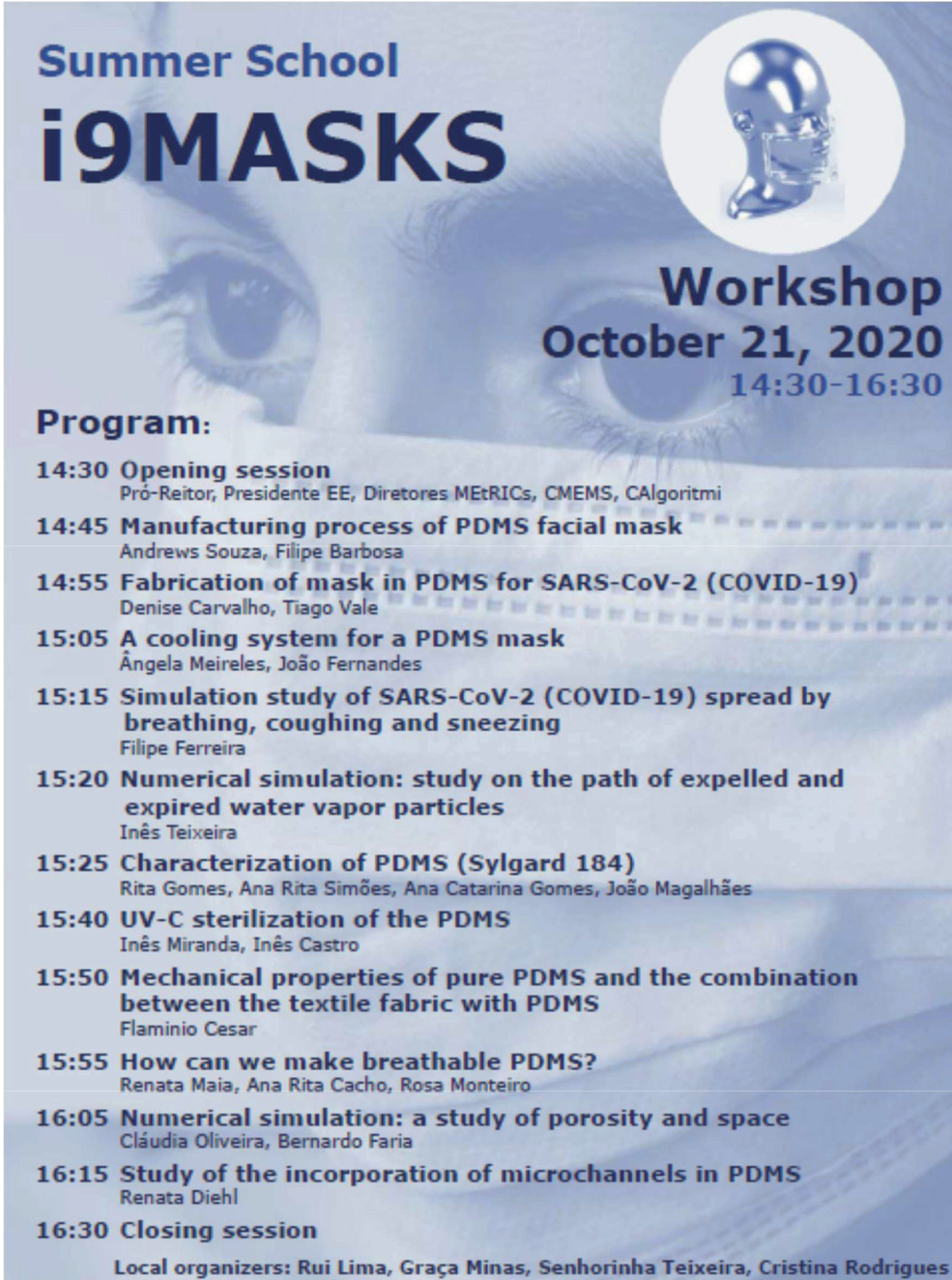















**Summer School**  
**i9MASKS**

**Workshop**  
**October 21, 2020**  
14:30-16:30

**Program:**

- 14:30 Opening session**  
Pró-Reitor, Presidente EE, Diretores METRICs, CMEMS, CAlgoritmi
- 14:45 Manufacturing process of PDMS facial mask**  
Andrews Souza, Filipe Barbosa
- 14:55 Fabrication of mask in PDMS for SARS-CoV-2 (COVID-19)**  
Denise Carvalho, Tiago Vale
- 15:05 A cooling system for a PDMS mask**  
Ângela Meireles, João Fernandes
- 15:15 Simulation study of SARS-CoV-2 (COVID-19) spread by breathing, coughing and sneezing**  
Filipe Ferreira
- 15:20 Numerical simulation: study on the path of expelled and expired water vapor particles**  
Inês Teixeira
- 15:25 Characterization of PDMS (Sylgard 184)**  
Rita Gomes, Ana Rita Simões, Ana Catarina Gomes, João Magalhães
- 15:40 UV-C sterilization of the PDMS**  
Inês Miranda, Inês Castro
- 15:50 Mechanical properties of pure PDMS and the combination between the textile fabric with PDMS**  
Flaminio Cesar
- 15:55 How can we make breathable PDMS?**  
Renata Maia, Ana Rita Cacho, Rosa Monteiro
- 16:05 Numerical simulation: a study of porosity and space**  
Cláudia Oliveira, Bernardo Faria
- 16:15 Study of the incorporation of microchannels in PDMS**  
Renata Diehl
- 16:30 Closing session**

Local organizers: Rui Lima, Graça Minas, Senhorinha Teixeira, Cristina Rodrigues







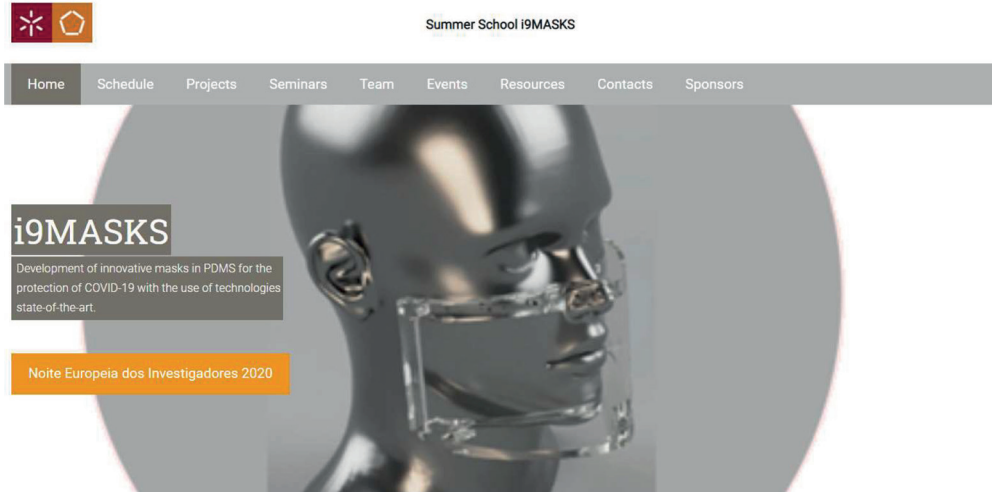



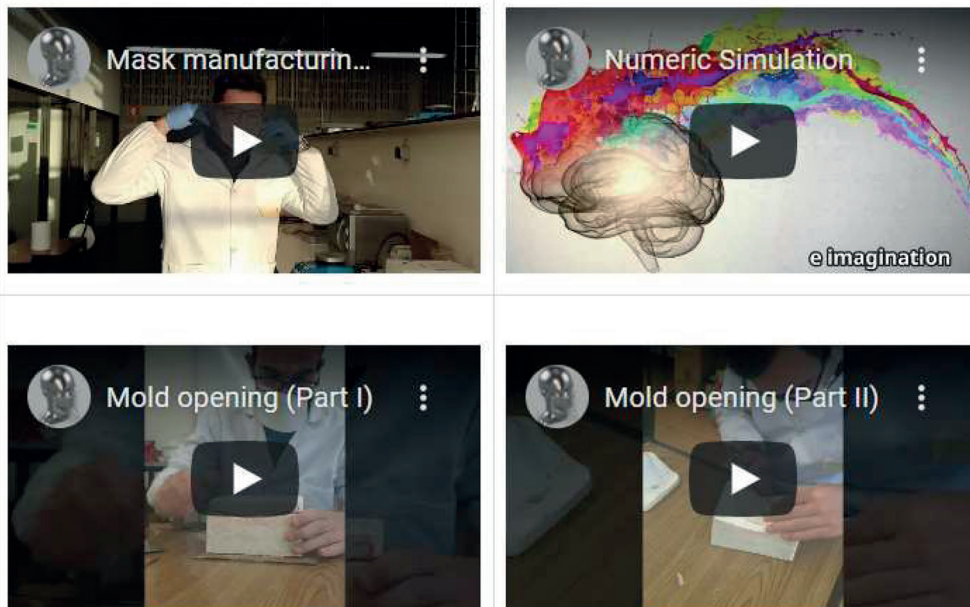





website

<http://i9masks-1.mozello.com/>



Videos



[https://www.youtube.com/watch?v=Z6md5LHysTE&feature=emb\\_logo](https://www.youtube.com/watch?v=Z6md5LHysTE&feature=emb_logo)

[https://www.youtube.com/watch?v=-kZrKiFh99A&feature=emb\\_logo](https://www.youtube.com/watch?v=-kZrKiFh99A&feature=emb_logo)

[https://www.youtube.com/watch?v=jRMk7arolJo&feature=emb\\_logo](https://www.youtube.com/watch?v=jRMk7arolJo&feature=emb_logo)

[https://www.youtube.com/watch?v=y-xjJQAWyA&feature=emb\\_logo](https://www.youtube.com/watch?v=y-xjJQAWyA&feature=emb_logo)



UMinho Editora



Universidade do Minho

ISBN 978-989-8974-32-7



9 789898 974327 >