

Chestnut wood in compression perpendicular to the grain: Non-destructive correlations for test results in new and old wood

Paulo B. Lourenço ^{a,*}, Artur O. Feio ^{a,1}, José S. Machado ^{b,2}

^a *Department of Civil Engineering, University of Minho, Azurém, P-4800-058 Guimarães, Portugal*

^b *National Laboratory for Civil Engineering, Timber Structures Division, Lisbon, Portugal*

Received 2 August 2005; received in revised form 13 January 2006; accepted 31 July 2006

Available online 20 September 2006

Abstract

This paper addresses the evaluation of the compressive properties of chestnut wood under compression perpendicular to the grain, using destructive and non-destructive methods. Three non-destructive methods (ultrasonic testing, Resistograph and Pilodyn) are proposed and the possibility of their application is discussed based on the application of simple linear regression models. Timber specimens were tested up to failure, divided in two different groups for assessing a possible load history related degradation, namely New Chestnut Wood (NCW), never been used structurally, and Old Chestnut Wood (OCW), obtained from structural elements belonging to ancient buildings. The specimens were also divided into four groups according to the orientation of annual growth rings towards load and wave propagation direction. The results show, in general, good correlations between compression strength and stiffness with non-destructive techniques via ultrasonic testing, Resistograph and Pilodyn. However, the orientation of the loading direction with respect to the annual growth rings must be taken into account. This conclusion, and the observation that NCW and OCW shows correlations and regression models usually different, add additional complexity to the quantitative use of non-destructive evaluation techniques for the assessment of the mechanical behaviour of timber elements.

© 2006 Elsevier Ltd. All rights reserved.

Keywords: Chestnut wood; Compression perpendicular to the grain; Non-destructive methods; Ultrasonic testing; Resistograph; Pilodyn; Ancient structures

1. Introduction

Timber is an anisotropic material showing significant mechanical properties differences when loaded parallel or perpendicular to grain. A ratio between parallel and perpendicular strength of 30:1 in tension and 5:1 in compression is generally found for hardwoods species. In the case of traditional timber buildings, given the marginal strength of wood in tension perpendicular to grain, the structural

system is usually conceived in such a way that any load transferred perpendicular to grain must be in compression. Therefore, wood compressive behaviour perpendicular to the grain is of crucial importance for design and safety assessment purposes.

In rehabilitation works of ancient timber structures, in situ inspection and evaluation of mechanical properties represent a first step towards diagnosis, structural analysis and possible remedial measures. Structural assessment comprises the need for answers regarding strength of sound timber elements, as well as regarding the effect of local damage due to biological attack (usually associated with excessive moisture). Non-destructive evaluation (NDE) plays a key role here, usually adopted for qualitative evaluation. Gradual steps towards quantitative evaluation have

* Corresponding author. Tel.: +351 253 510 209; fax: +351 253 510 217.

E-mail addresses: pbl@civil.uminho.pt (P.B. Lourenço), af@civil.uminho.pt (A.O. Feio), saporiti@lnec.pt (J.S. Machado).

¹ Tel.: +351 253 510 200; fax: +351 253 510 217.

² Tel.: +351 21 8443299; fax: +351 21 8443025.

been made recently since the removal of samples and their destructive testing is time-consuming, unpractical and, often, even not feasible.

The efficiency and reliability of NDE methods can be increased if extensive laboratorial tests are used to provide correlations with the mechanical characteristics of wood [1,2]. In particular, the last decades witnessed developments in the NDE techniques, equipments and methods that allow increasing their accuracy. NDE can be grouped in Global Test Methods (GTM) and Local Test Methods (LTM) [3,4]. The former includes e.g. the application of the ultrasonic and vibration methods [5,6]. The latter plays usually a leading role in the support of visual inspection, being the Resistograph [7] and the Pilodyn [8] the most common techniques. The general characteristic of all methods is their easy usage and transport, plus the fast in situ application.

The most relevant material properties when dealing with compression perpendicular to the grain are the compressive strength and the elasticity modulus. Experimentally, these properties can be obtained according to different standards, being the Brazilian Standard NBr 7190 [9] adopted in the present paper. Wood micro-structure leads to behaviour in compression perpendicular to the grain characterized by an absence of a clear failure of the material associated with very high strains. In addition, the loading direction with respect to the annual growth rings leads to very different stress–strain diagrams. In fact several authors consider the loading direction more important than the differences between wood species [10,11].

Some authors pointed out that wood behaviour in radial compression is strongly dependent on its anatomical features [10,12,13], but others authors believe that elastic behaviour is more dependent on density than on anatomical characteristics [14,15]. In practical situations, the influence of the loading direction seems less relevant due to the difficulties of finding, in a real structure, timber elements exhibiting a particular orientation. Therefore, tests should be made using random loading directions. It must be also taken into account that the failure mode observed for a 45° slope, which provides the lowest strength values for transversal compression [16], is common in prismatic standardized specimens without apparent defects, but it is rarely observed either when structural dimensions specimens are used or in engineering applications.

The testing set-up and procedure also seems to have direct influence on the derivation of strength and elastic properties. Depending on shape and dimensions, thickness and stressed area, different relations between strength and elastic properties of wood may be obtained [17,18].

The impact of load history and time over strength and stiffness of structural timber elements has raised some discussions but generally, if no damaging action occurred, there is no loss of mechanical properties. This observation is also due to the large range of strength values generally obtained for each wood species and grade (coefficient of variation around 20–40%). Usually, inspection of old tim-

ber structures show that large deformations, that could possibly have been linked to exceptional loading conditions, are often the result of using green round or square elements and excessive moisture conditions during the history of the structure.

The objective of this paper is to discuss the possibility of using NDE methods for the evaluation of strength and stiffness of chestnut wood (*Castanea sativa* Mill.) in compression perpendicular to grain. This wood is usually present in historical Portuguese buildings, given not only its mechanical and durability properties, but also its aesthetic characteristics. The effect of annual rings orientation towards load direction and the effect of age-related degradation are taken into account. Regression analyses are carried out in order to obtain correlations between mechanical properties and density and non-destructive methods.

2. Test specimens

The average size of the specimens adopted in the testing program was originally $50 \times 50 \times 300 \text{ mm}^3$. Ultrasonic tests were carried out in these specimens and, afterwards, each specimen was cut in three smaller samples of $50 \times 50 \times 100 \text{ mm}^3$: two specimens were tested in laboratory up to

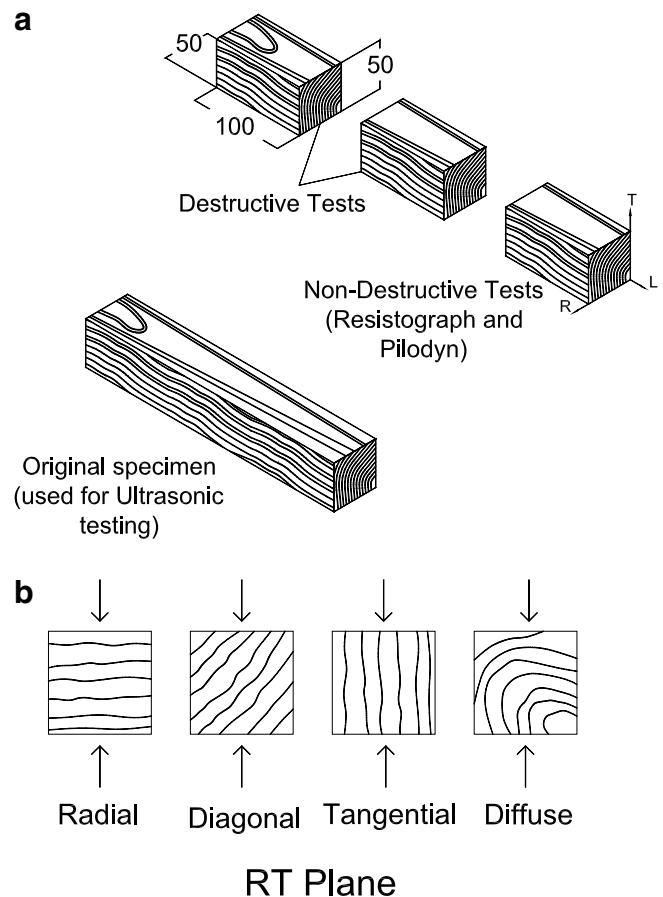

Fig. 1. Specimens used in the testing program: (a) nominal dimensions in mm and (b) annual growth rings orientation with respect to the loading direction.

failure, and the third specimen was used for the additional non-destructive tests (Resistograph and Pilodyn 6J), see Fig. 1a. The specimens were divided in different groups taking into account the orientation of the annual growth rings with respect to the direction of loading. This approach is absolutely necessary for adequate insight in the experimental results. Four groups were considered: (i) radial, (ii) diagonal, (iii) tangential and (iv) diffuse, as shown in Fig. 1b.

In total, 160 specimens of chestnut wood were tested up to failure. The specimens were also divided in two groups: New Chestnut Wood (NCW), which has never been used structurally even so it comes from logs that could be used as such, and old chestnut wood (OCW), which was used as part of structural elements belonging to ancient buildings (date and precise origin unknown). The old logs have been obtained from a specialist contractor claiming that the wood has been in service for over 50 years. All wood comes from the Northern region of Portugal.

Before testing, the specimens were conditioned in a climatic room capable of keeping constant temperature (20 ± 2 °C) and humidity ($65 \pm 5\%$). The tests specimens were considered conditioned when the density variation was smaller than 0.5% in a period of 2 h, as recommended by the EN 408 standard [19]. The densities were measured using an electronic weighing machine with a precision of 0.01 g.

3. Characterization of physical and mechanical properties

3.1. Density

Density was measured according to EN 408 standard [19]. Given the conditioning of the specimens, the average density ρ_m is determined for a moisture content of 12%, given by

$$\rho_{12\%} = \frac{m_{12\%}}{V_{12\%}} \quad (1)$$

Here, m indicates the mass and V indicate the volume. Table 1 presents the results for the average density and the coefficient of variation organized according to two group types (loading orientation and age).

On average and for the complete 160 specimens sample, the densities of OCW and NCW groups are similar (differences smaller than 2%). Density differences between the smaller groups defined by loading orientation are larger, but still with a maximum of 5%: the maximum average density of a group is 599.8 kg/m^3 for tangential OCW

and the minimum density of a group is 567.9 kg/m^3 for tangential NCW. This indicates that, optimally, a larger sample would be required in each group.

3.2. Uniaxial compression tests

Mechanical testing was carried out using a Baldwin universal testing machine, with a load cell of 300 kN. A power supply Schenk equipment was used, together with a HBM system (Spider 8) for the acquisition and amplification of the data, see Fig. 2a. Strain gages were attached to all faces of the specimens (typically a DD1 type from HBM, with a range of ± 2.5 mm, a sensitivity of ± 2.5 mV/V and a linear deviation of $\pm 0.05\%$), see Fig. 2b.

The adopted test procedure follows the Brazilian Standard NBr 7190 [9], which includes two loading–unloading cycles before continuously increasing loading up to failure. The loading rate is 6×10^{-3} mm/s in the loading–unloading phase, and 6×10^{-2} mm/s in the failure phase, being the stress–strain diagrams recorded continuously. The compressive strength $f_{c,90}$ perpendicular to the grain is defined as the conventional value determined by a residual deformation of 2%. The stiffness of wood, in the direction perpendicular to the grain, is determined by its modulus of elasticity $E_{c,90}$. This secant modulus is conventionally defined as the slope of the linear part in the stress–strain relationship, between 10% and 50% of the conventional failure stress, given by

$$E_{c,90} = \frac{\sigma_{50\%} - \sigma_{10\%}}{\varepsilon_{50\%} - \varepsilon_{10\%}} \quad (2)$$

where $\sigma_{10\%}$ and $\sigma_{50\%}$ are the stresses corresponding to 10% and 50% of the failure conventional stress, and $\varepsilon_{10\%}$ and $\varepsilon_{50\%}$ are the strains corresponding to the values of $\sigma_{10\%}$ and $\sigma_{50\%}$. Finally, the Poisson ratios are calculated equally as secant values for the same stress range of the conventional failure stress.

An electronic device registered the air temperature and relative humidity during the tests. The average values of temperature and relative humidity were 24 ± 2 °C and $52 \pm 12\%$, respectively. The time elapsed between the tests and withdrawal of the specimens from the climatic chamber (less than 24 h) did not affect the conditioning of the specimens.

The results of the uniaxial compression tests are again presented taking into account the loading orientation and age, Table 2. The values for the coefficient of variation are relatively large (average CV of 16%) but well within the variability found for wood species tested in compres-

Table 1
Density and number of specimens

	Radial		Diagonal		Tangential		Diffuse		Total	
	NCW	OCW	NCW	OCW	NCW	OCW	NCW	OCW	NCW	OCW
No. specimens	19	12	22	30	19	12	20	26	80	80
ρ_m (kg/m ³)	579.8	607.9	593.8	587.2	567.9	599.8	600.2	594.1	585.4	597.2
CV (%)	8.4	5.2	7.6	6.4	6.6	4.6	4.4	6.4	6.8	5.7

Table 2
Mechanical properties of chestnut wood in compression perpendicular to the grain

	$E_{c,90}$ (N/mm ²)	$f_{c,90}$ (N/mm ²)	$E_{c,90}$ (N/mm ²)	ν_{RL} (-)	ν_{TR} (-)	ν_{LT} (-)	$f_{c,90}$ (N/mm ²)	$E_{c,90}$ (N/mm ²)	ν_{RL} (-)	ν_{TR} (-)	ν_{LT} (-)	$f_{c,90}$ (N/mm ²)
	Radial (total)			Radial (NCW)			Radial (OCW)					
Average	787	7.56	783	0.04	0.33	0.13	7.45	794	0.05	0.32	0.16	7.74
CV(%)	17	24	15	17	11	13	22	19	27	18	18	28
	Diagonal (total)			Diagonal (NCW)			Diagonal (OCW)					
Average	606	6.81	612	0.06	0.36	0.18	6.99	601	0.06	0.35	0.17	6.67
CV (%)	11	17	12	16	9	13	19	9	17	8	16	16
	Tangential (total)			Tangential (NCW)			Tangential (OCW)					
Average	543	6.92	526	0.05	0.28	0.19	6.58	569	0.06	0.33	0.17	7.47
CV (%)	13	23	14	18	13	13	14	10	8	9	7	10
	Diffuse (total)			Diffuse (NCW)			Diffuse (OCW)					
Average	583	6.55	552	0.04	0.26	0.16	6.22	607	0.04	0.27	0.15	6.81
CV (%)	18	17	11	22	16	13	10	21	22	12	18	21

sion perpendicular to grain. The main conclusion is that the difference in the results between old and new wood is moderate to very low. The design of new timber structures and the design of strengthening for existing timber structures can be carried out using the same mechanical data, as indicated in [20]. The results also indicate that the com-

pressive strength and stiffness perpendicular to the grain reaches a maximum in the radial direction. The differences between diagonal, tangential and diffuse loading directions are, on average, only moderate.

Fig. 3 shows the most common failure patterns observed, described as follows:

- in radial compression, the dense latewood layers are arranged in series between weak earlywood bands and the limiting factor is the “weak-layered” earlywood, see Fig. 3b. The initial failure is caused by the weakest layer, followed by other “weak-layers” upon increasing load, in a process that decrease the cross-section height. At the end of the test, a large compaction of “weak-layers” is found;
- the diagonal behaviour can be classified as an intermediate situation between radial and tangential behaviour: (i) the initial failure occurs in an initial earlywood “weak-layer”, followed by other “weak-layers” upon increasing load, in a process that decrease the cross-section height; (ii) at a certain stage, failure shifts to early bond failure between earlywood and latewood layers. With increasing load, separation between these layers can be observed, similar to the tangential behaviour (see Fig. 3c);
- the tangential behaviour can be explained by the early bond failure between earlywood and latewood layers. With increasing load, separation between these layers can be observed. Also, buckling failure can be observed as a result of the low slenderness that individual earlywood and latewood layers possess along their axes, see Fig. 3d.

4. Description of non-destructive test procedures

4.1. Resistograph tests

The Resistograph is a commercial testing equipment based in micro-drilling wood at constant speed, and mea-

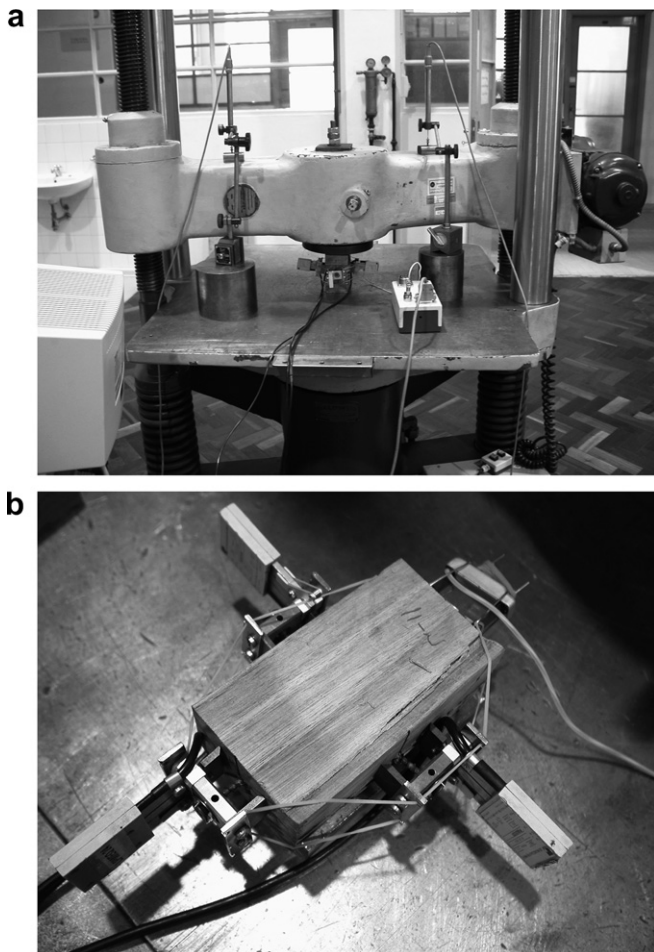

Fig. 2. Test set-up: (a) general view and (b) specimen with attached strain gages (top view).

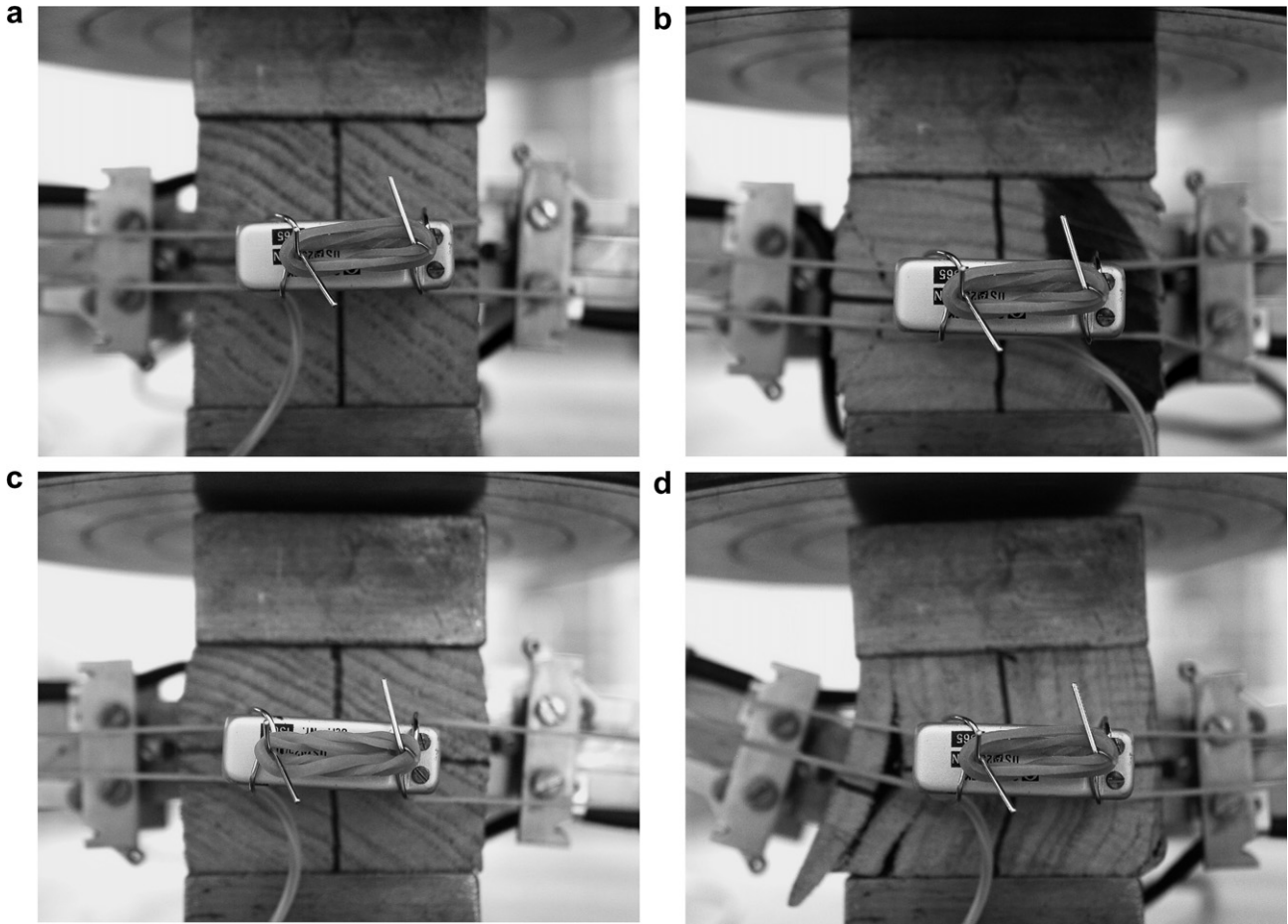

Fig. 3. Behaviour in failure: (a) initial specimen, (b) typical radial failure, (c) typical diagonal failure, and (d) typical tangential failure.

asuring the energy required for maintaining that speed. The Resistograph is usually adopted to obtain density profiles and, in the present testing program, drilling was made parallel to plane RT (planes TL and LR), which, in real cases, represents the accessible faces of timber elements. For each specimen, three independent profiles have been carried out and the results shown represent the average of the readings.

For all the specimens, as a function of the obtained graphs with the Resistograph, a resistographic measure (RM) was calculated. The selected resistographic measure represents the ratio between the integral of the area of the diagram and the length l of the drilled perforation (see Eq. (3)). Using this scalar measure, the Resistograph results can be easily compared with the values of density and of the elastic properties.

$$RM = \frac{\int_0^l Area}{l} \quad (3)$$

4.2. Pilodyn 6J tests

The Pilodyn 6J is a device that, through the release of a spring, transforms the elastic potential energy into impact energy. This way the penetration of a metallic needle with

2.5 mm of diameter can be measured and the depth is inversely proportional to the density of the wood. Planes TL and LR of the specimens were again used for measurements. The Pilodyn 6J was used only with the aim of

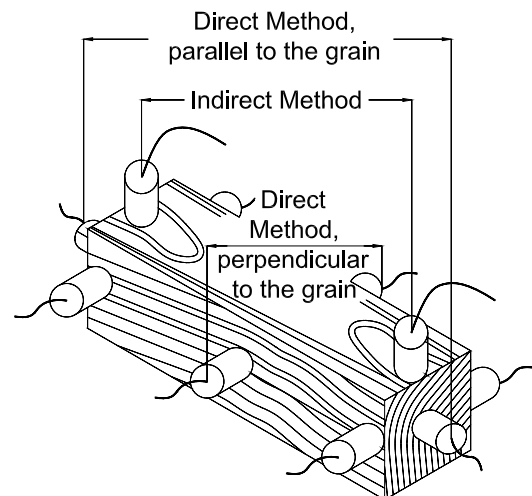

Fig. 4. Test set-up for ultrasonic testing: indirect method, direct method, parallel to the grain, and direct method, perpendicular to the grain.

Table 3
Influence of the ring orientation in the UPV (indirect method)

	UPV (m/s)		UPV (m/s)		UPV (m/s)		UPV (m/s)		
	Radial		Diagonal		Tangential		Diffuse		
	NCW	OCW	NCW	OCW	NCW	OCW	NCW	OCW	
Average	4481.5	4619.9	4474.5	4403.7	4527.2	4834.7	4587.6	4431.8	
CV (%)	5.1	6.7	5.6	4.0	3.5	2.6	3.4	2.0	
Total									
Average	4535.1		4432.6		4646.2		4499.5		
CV (%)	5.9		4.7		4.5		3.2		

correlating the density and elastic properties with the depth reached with the needle of the device (surface hardness or resistance to superficial penetration). For each specimen, three independent impact tests have been carried out and the results shown represent the average of the readings.

4.3. Ultrasonic tests

The ultrasonic tests were carried out using the equipment Pundit/Plus, with cylinder-shaped transducers of

150 kHz. Although three methods were used in the framework of a more general approach, see Fig. 4 (indirect method; direct method parallel to the grain, and direct method perpendicular to the grain), the only method reported in this paper is the Indirect Method, since it is the most appropriate in practical cases. The Indirect Method can be used for evaluating different zones of the element (global or local evaluation) and only needs a face of the element to be accessible. Regarding the direct method parallel to the grain, it requires access to the ends of the elements (in most cases not possible) and allows only a global evaluation of the material (it is not possible to

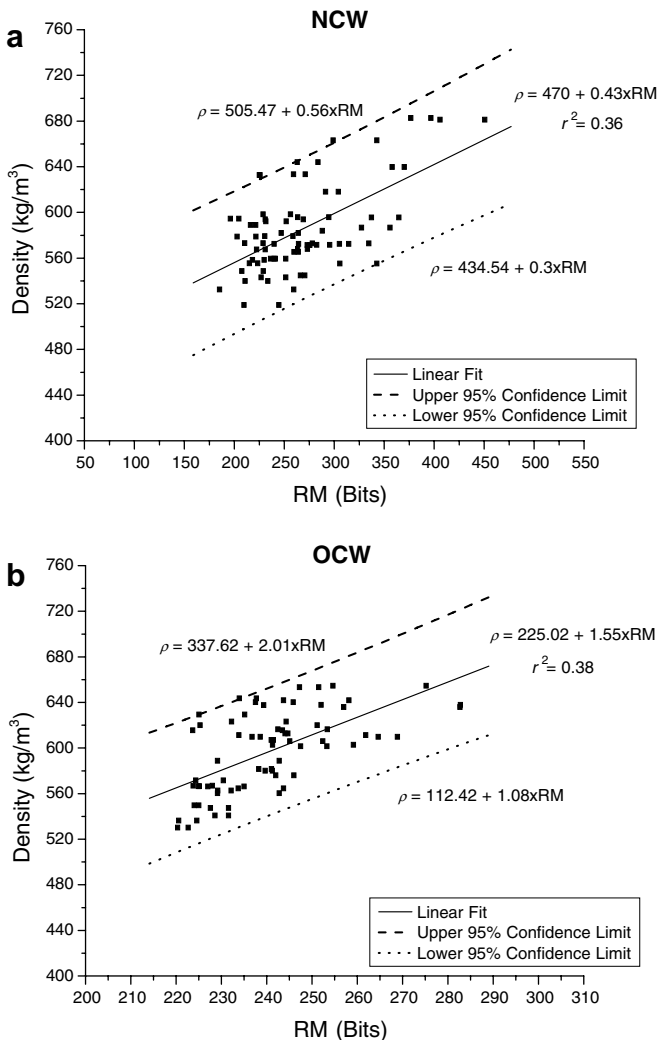

Fig. 5. Relation between RM and density: (a) NCW and (b) OCW.

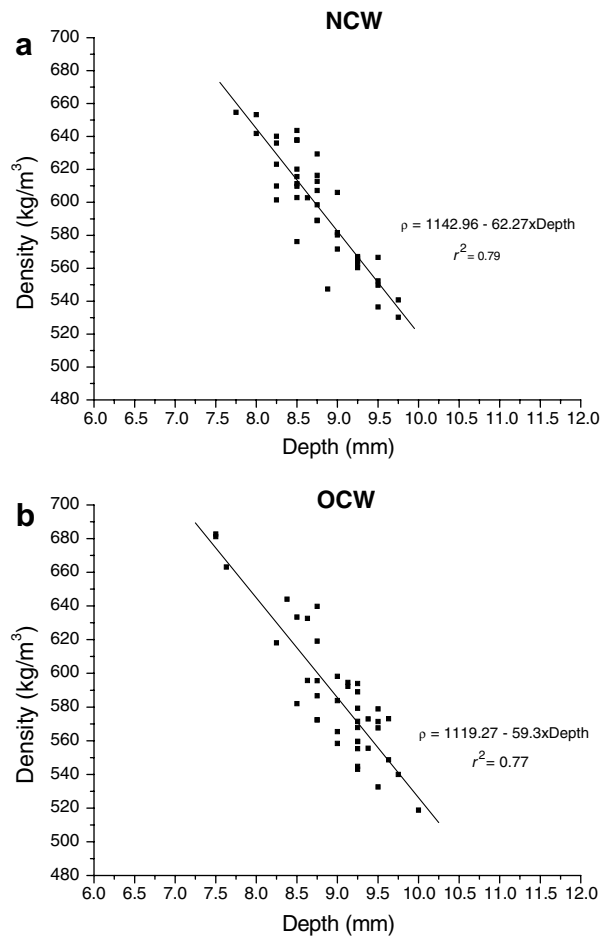

Fig. 6. Relation between pin depth (Pilodyn) and density: (a) NCW group and (b) OCW group.

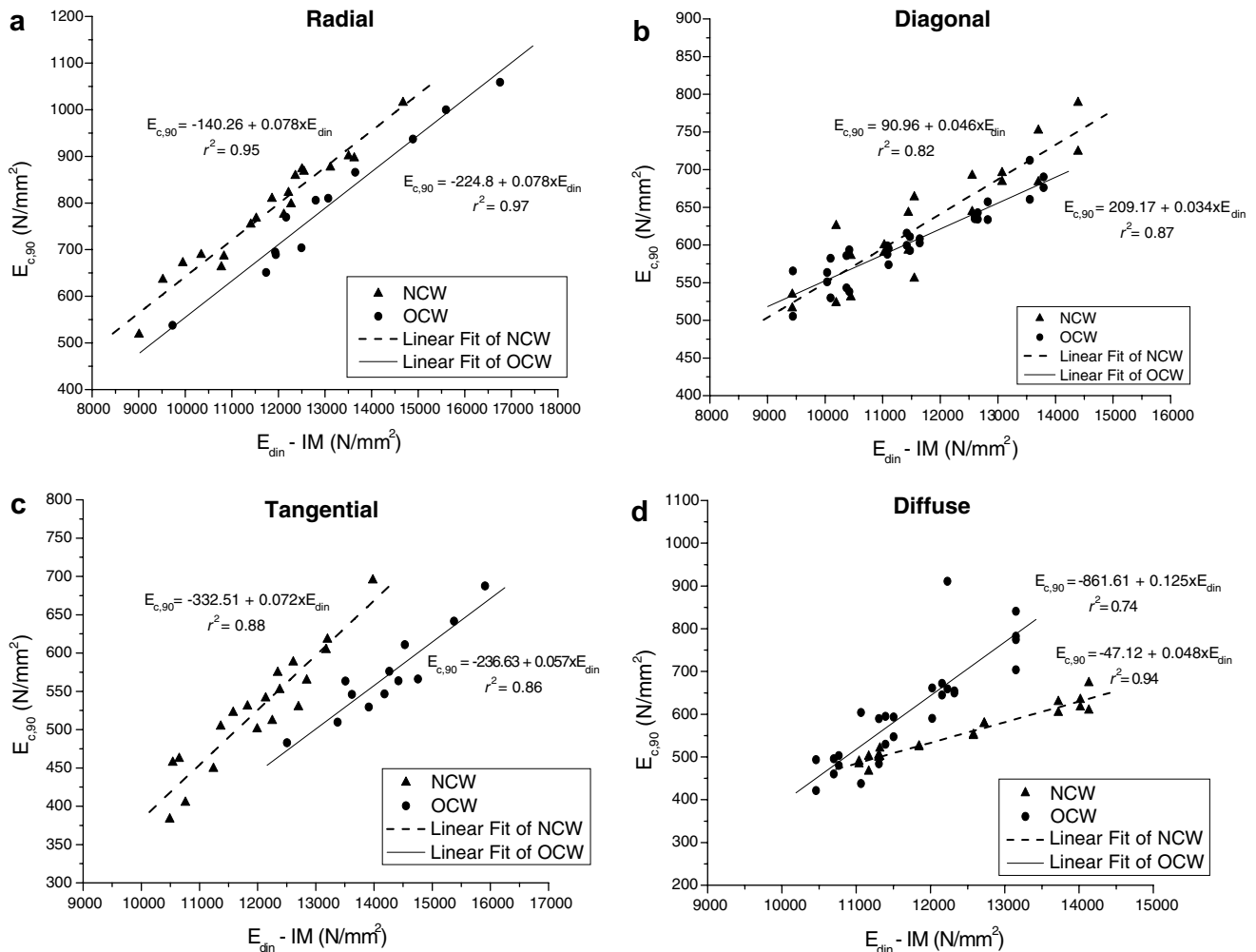

Fig. 7. Relation between E_{din} and $E_{c,90}$, using the indirect method, for the: (a) radial group, (b) diagonal group, (c) tangential group, and (d) diffuse group. Both NCW and OCW are considered.

evaluate weak or critical zones in the element). Finally, the direct method perpendicular to the grain, only gives a local evaluation of the element and it needs access to two opposite faces of the element.

The transmission technique of elastic waves based on the indirect method was used in all the faces, for the case of diagonal and diffuse tests specimens. For the case of radial and tangential tests specimens, the transducers were used in two opposite faces, depending on the orientation of annual growth rings.

In all tests, coupling between the transducers and specimens was assured by a conventional hair gel and a constant pressure was applied by means of a rubber spring, allowing adequate transmission of the elastic wave between the transducers and the specimen under testing.

The propagation velocity of the longitudinal stress waves in an elastic media depends essentially on the stiffness and the density of the media. For prismatic, homogeneous and isotropic elements and for those with section width smaller than the stress wavelength, the relation:

$$E_{din} = u^2 \cdot \rho \quad (4)$$

holds, where E_{din} represents the dynamic modulus of elasticity (N/mm^2); u is the propagation velocity of the longitudinal stress waves (m/s), usually denoted by UPV (ultrasonic pulse velocity), and ρ is the density of the specimens (kg/m^3).

Table 3 presents the influence of the ring orientation in the propagation of stress waves, which is marginal for the indirect method. In the case of the direct method, the influence of the ring orientation is rather severe and must be taken into account.

5. Correlations based in the NDT methods

5.1. Correlations with density

Fig. 5 shows the correlations between the resistographic measure and the density for the NCW and OCW groups. The scatter in the results is too high and no correlation can be found between the two quantities. In addition, the difference between the groups of NCW and OCW is also too large. For practical purposes, it is not recommended to use this measure as a quantitative indicator. Considering

all tests together, a lower 95% confidence limit is given by the following expression:

$$\rho = 456.8 + 0.27 \cdot \text{RM} \quad (5)$$

Fig. 6 shows the correlations between the pin depth of the Pilodyn and the density for the NCW and OCW groups. The scatter in the results is moderate and a reasonable correlation between the two quantities is found. The results are independent of the orientation of the annual growth rings and the wood age. Considering all tests together, the average correlation is given by the following expression (r^2 is equal to 0.78):

$$\rho = 1115.16 - 60.1 \cdot \text{Depth} \quad (6)$$

It is noted that the pin penetrates only 6–14 mm into wood. This means that it penetrates only between one and three annual growth rings. Therefore, the result is only superficial and care must be taken in practical applications, taking into account if the outer surface is deteriorated due to biological attack.

5.2. Correlations with the elasticity modulus

Fig. 7 shows the correlations between E_{din} and $E_{\text{c},90}$ using the indirect method. As expected [21], very good linear correlations were found but it is necessary to use different correlations according to the load orientation and wood age. In the comparison of the same loading direction but different ages, it is striking that the slope of the linear correlations is equal in the case of the radial specimens, it is similar in the case of the diagonal and tangential specimens (analysed separately), and it is totally different in the case of the diffuse specimens. This is obviously due to the possibility of rather different configurations of the annual growth rings for the diffuse specimens. Also, these results are in agreement with the discussion provided in the previous section. It is noted that the correlations with E_{din} are much better than with the UPV, meaning that the knowledge of the wood density, see Eq. (4), is of utmost importance for obtaining reliable correlations. Considering all tests together, a lower 95% confidence limit is given by the following expression:

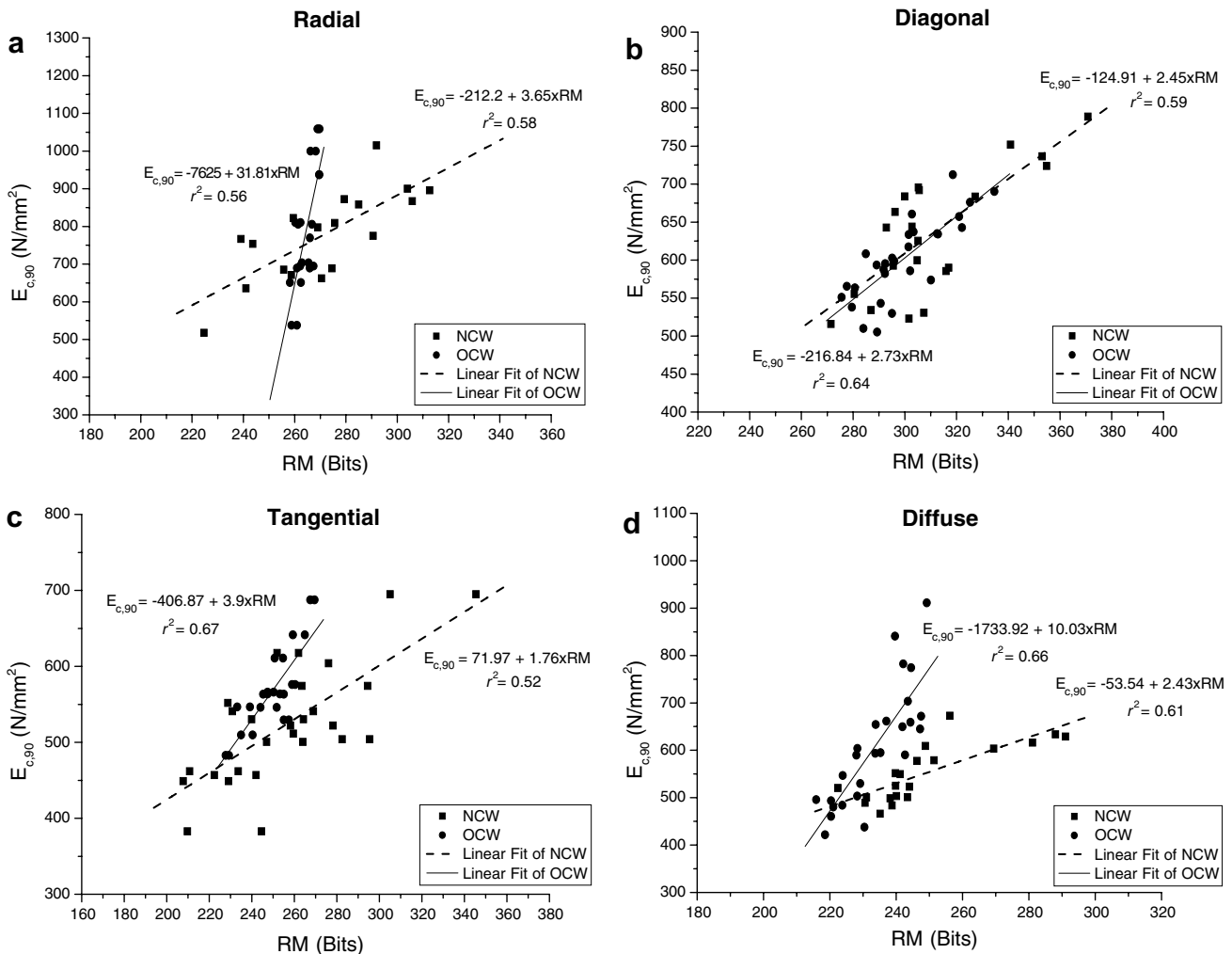

Fig. 8. Relation between RM and $E_{\text{c},90}$ for the: (a) radial group, (b) diagonal group, (c) tangential group, and (d) diffuse group. Both NCW and OCW are considered.

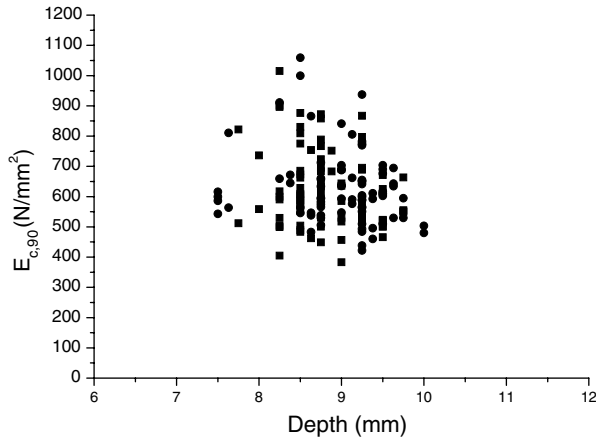

Fig. 9. Relation between pin depth (Pilodyn) and $E_{c,90}$ for the NCW and OCW groups.

$$E_{c,90} = -74.4 + 0.035 \cdot E_{din} \quad (7)$$

Fig. 8 shows the correlations between the resistographic measure and the elasticity modulus for the NCW and OCW groups. Weak linear correlations were found but it

is necessary to use different correlations according to the load orientation and wood age. For practical purposes, it is not recommended to use this measure as a quantitative indicator. Considering all tests together, a lower 95% confidence limit is given by the following expression:

$$E_{c,90} = 68.11 + 0.98 \cdot RM \quad (8)$$

Fig. 9 shows the correlation between the depth reached with the needle of the Pilodyn device and the elasticity modulus for the NCW and OCW groups. No correlation was found and it is not recommended to use this measure as a quantitative indicator. Still, a lower 95% confidence limit is given by the following expression:

$$E_{c,90} = 714.36 - 82.46 \cdot \text{Depth} \quad (9)$$

5.3. Correlations with the uniaxial compressive strength

Fig. 10 shows the correlations between E_{din} and $f_{c,90}$ using the indirect method. Good linear correlations were found but, again, it is necessary to use different correlations according to the load orientation and wood age. If the

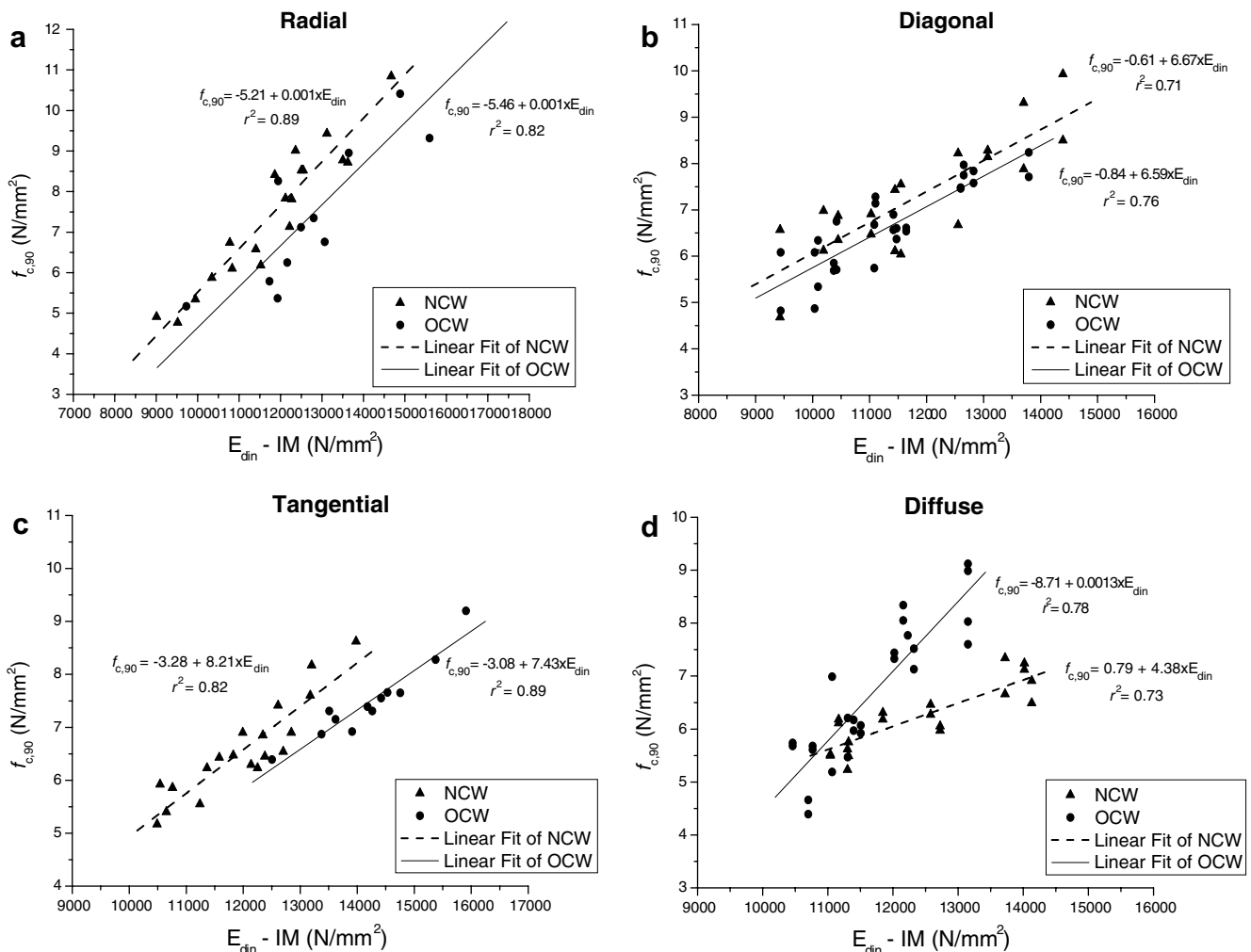

Fig. 10. Relation between E_{din} and $f_{c,90}$, using the Indirect Method, for the: (a) radial group, (b) diagonal group, (c) tangential group, and (d) diffuse group. Both NCW and OCW are considered.

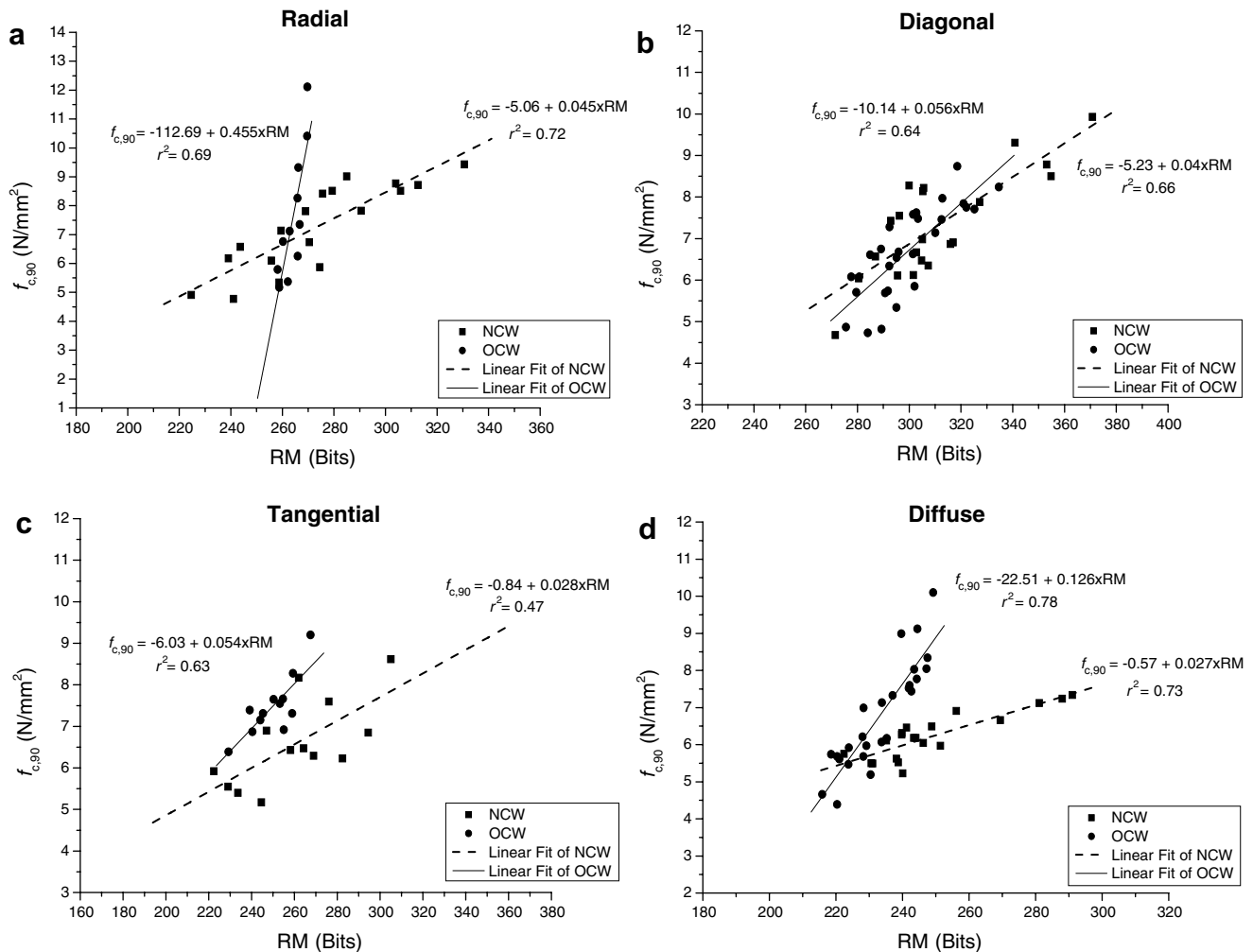

Fig. 11. Relation between RM and $f_{c,90}$ for the: (a) radial group, (b) diagonal group, (c) tangential group, and (d) diffuse group. Both NCW and OCW are considered.

comparison is made for the same loading direction but different ages, it is even more striking that the slope of the linear correlations is equal in the case of the radial, diagonal and tangential specimens (analysed all separately), and it is

totally different in the case of the diffuse specimens. Considering all tests together, a lower 95% confidence limit is given by the following expression:

$$f_{c,90} = -2.33 + 5.82 \cdot E_{\text{din}} \quad (10)$$

Fig. 11 shows the correlations between the resistographic measure and the uniaxial compressive strength for the NCW and OCW groups. Weak linear correlations were found but it is necessary to use different correlations according to the load orientation and wood age. For practical purposes, it is not recommended to use this measure as a quantitative indicator. Considering all tests together, a lower 95% confidence limit is given by the following expression:

$$f_{c,90} = 0.67 + 0.011 \cdot \text{RM} \quad (11)$$

Fig. 12 shows the correlation between the depth reached with the needle of the Pilodyn device and the elasticity modulus for the NCW and OCW groups. Again, no correlation was found and it is not recommended to use this measure as a quantitative indicator. Still, a lower 95% confidence limit is given by the following expression:

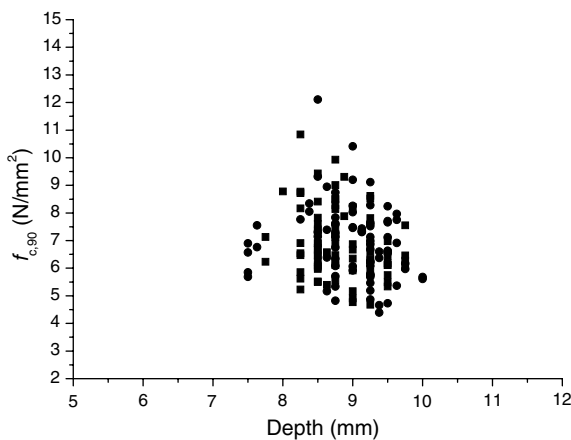

Fig. 12. Relation between pin depth (Pilodyn) and $f_{c,90}$ for the NCW and OCW groups.

$$f_{c,90} = 7.67 - 0.85 \cdot \text{Depth} \quad (12)$$

6. Conclusions

The analysis of the tests carried out in timber specimens indicates that results must take into account the orientation of the annual growth rings, not only in terms of numerical values but also in terms of observed failure modes. In this paper, both new and old sound chestnut wood are considered in the testing program.

As a first conclusion, it is possible to confirm that load history and time do not change the mechanical and physical properties of sound wood. The design of new timber structures and rehabilitation projects can be carried out using similar mechanical and physical values for new and old chestnut wood. A second conclusion is that transverse elasticity modulus and compressive strength reach a maximum for radial orientation of loading, and the global behaviour can be explained by the relation between early-wood and latewood.

Finally, novel correlations have been proposed for density, elasticity modulus and compressive strength perpendicular to the grain, using the resistograph, pilodyn and ultrasonic testing. With respect to density, the resistograph must be used carefully because no correlation could be found, while the results for the pilodyn provide good correlations that are independent of the wood age. With respect to mechanical characteristics, reasonable correlations have been obtained in general taking into account the wood age and loading orientation. As this is not reasonable for practical purposes, expressions with a lower 95% confidence have been proposed.

The correlations obtained with the dynamic modulus of elasticity via ultrasonic testing were very good but this requires the knowledge of the density, which adds complexity to the non-destructive testing technique.

Acknowledgement

The financial support by the Portuguese Foundation for Science and Technology (FCT) under grant SFRH/BD/5002/2001 awarded to the second author is gratefully acknowledged.

References

- [1] Ross R, Brashaw B, Pellerin R. Non-destructive evaluation of wood. *Forest Products J* 1998;48(1):101–5.
- [2] Bonamini G, Noferi M, Togni M, Uzielli L. Handbook for structural timber: vol. 1—in situ inspection and diagnosis (in Italian). Mancosu Editore. Rome. ISBN-88-87017-01-8 2001.
- [3] Bertolini C, Brunetti M, Cavallaro P, Macchioni N. A non-destructive diagnostic method on ancient timber structures: some practical application examples. In: Proceedings of 5th world conference on timber engineering. Montreux. Presses Polytechniques et Universitaires Romandes. 1998;vol. I: 456–465.
- [4] Ceraldi C, Mormone V, Ermolli E. Resistographic inspection of ancient timber structures for the evaluation of mechanical characteristics. *Mater Struct RILEM* 2001;34(January–February):59–64.
- [5] Sandoz J. Grading of construction timber by ultrasound. *Wood Sci Technol* 1989;23:95–108.
- [6] Ross R, DeGroot R, Nelson W, Lebow P. The relationship between stress wave transmission characteristics and the compressive strength of biologically degraded wood. *Forest Products J* 1997;47(5):89–93.
- [7] Rinn F, Schweingruber F, Schär E. Resistograph and X-ray density charts of wood comparative evaluation of drill resistance profiles and X-ray density charts of different wood species. *Holzforschung—Int J Biol, Chem, Phys Technol Wood* 1996;50(4):303–11.
- [8] Görlacher R. Non-destructive testing of wood: an in situ method for determination of density. *Holz als Roh-und Werkstoff* 1987;45:273–8.
- [9] Brazilian standard. Nbr7190—Design of timber structures (in Portuguese). ABNT. Brazil, 1997.
- [10] Bodig J. Improved load-carrying capacity of wood in transverse compression. *Forest Products J* 1969;19(12):39–44.
- [11] Tabarsa T, Chui Y. Characterizing microscopic behaviour of wood under transverse compression. Part II. Effect of species and loading direction. *Wood Fiber Sci* 2001;33(2):223–32.
- [12] Alexiou P. Elastic properties of *Eucalyptus pilularis* Sm. perpendicular to the grain. *Holzforschung—Int J Biol, Chem, Phys Technol Wood* 1994;48(1):55–66.
- [13] Müller U, Gindl W, Teischinger A. Effects of cell anatomy on the plastic and elastic behaviour of different wood species loaded perpendicular to grain. *IAWA J* 2003;24(2):117–28.
- [14] Kennedy W. Wood in transverse compression—influence of some anatomical variables and density on behavior. *Forest Products J* 1968;18(3):36–40.
- [15] Beery W, Ifju G, McLain T. Qualitative wood anatomy—relating anatomy to transverse tensile strength. *Wood Fiber Sci* 1983;15(4):395–407.
- [16] Ethington R, Eskelsen V, Gupta R. Relationship between compression strength perpendicular to grain and ring orientation. *Forest Products J* 1996;46(1):84–6.
- [17] Kunesh R. Strength and elastic properties of wood in transverse compression. *Forest Products J* 1968;18(1):65–72.
- [18] Bodig J. The peculiarity of compression of conifers in radial direction. *Forest Products J* 1963;13:438–46.
- [19] European Committee for Standardization. EN 384—Structural timber—determination of characteristic values of mechanical properties and density. Office for Official Publications of the European Communities. Luxembourg, 1995.
- [20] Kuipers J. Effect of age and/or load on timber strength. In: Proceedings of 19th CIB-W18/19-6-1, Florence, Italy, 1986.
- [21] Wood Handbook. Forest Service Agricultural Handbook, No. 72. U.S.D.A., 1974.